



# **The Qi Wireless Power Transfer System Power Class 0 Specification**

## **Parts 1 and 2: Interface Definitions**

**Version 1.2.3**

**February 2017**

**COPYRIGHT**

© 2015-2017 by the Wireless Power Consortium. All rights reserved.

The Qi Wireless Power Transfer System, Power Class 0 Specification, *Parts 1 and 2: Interface Definitions* is published by the Wireless Power Consortium, and has been prepared by the members of the Wireless Power Consortium. Reproduction in whole or in part is prohibited without express and prior written permission of the Wireless Power Consortium.

**DISCLAIMER**

The information contained herein is believed to be accurate as of the date of publication. However, neither the Wireless Power Consortium, nor any member of the Wireless Power Consortium will be liable for any damages, including indirect or consequential, from use of or reliance on the accuracy of this document. For any further explanation of the contents of this Specification, or in case of any perceived inconsistency or ambiguity of interpretation, or for any information regarding the associated patent license program, contact [info@wirelesspowerconsortium.com](mailto:info@wirelesspowerconsortium.com).

**RELEASE HISTORY**

Version	Release Date	Description
1.2.1	October 2015	Restructuring and renaming of Wireless Power Transfer System Descriptions.
1.2.2	April 2016	New WPID feature; technical updates to improve Q-factor measurements; over-voltage protection; technical and editorial corrections.
1.2.3	February 2017	Editorial updates and change requests addressed. See Annex E, History of Changes, for details.

## Contents

<b>1</b>	<b>General</b>	<b>8</b>
1.1	Introduction	8
1.2	Scope	8
1.2.1	Current Specification structure (introduced in version 1.2.1)	8
1.2.2	Earlier Specification structure (version 1.2.0 and below)	9
1.3	Main features of the Qi Wireless Power Transfer System	9
1.4	Conformance and references	10
1.4.1	Conformance	10
1.4.2	References	10
1.5	Definitions	11
1.6	Acronyms	15
1.7	Symbols	17
1.8	Conventions	18
1.8.1	Cross references	18
1.8.2	Informative text	18
1.8.3	Terms in capitals	18
1.8.4	Units of physical quantities	18
1.8.5	Decimal separator	18
1.8.6	Notation of numbers	19
1.8.7	Bit ordering in a byte	19
1.8.8	Byte numbering	19
1.8.9	Multiple-bit fields	20
1.9	Operators	20
1.9.1	Exclusive-OR	20
1.9.2	Concatenation	20
1.10	Measurement equipment	20

<b>PART 1: Primary Interface Definition .....</b>	<b>21</b>
<b>2 Mechanical interface .....</b>	<b>22</b>
2.1 Power Receiver design requirements (PRx).....	22
2.1.1 Interface Surface .....	22
2.1.2 Alignment Aid .....	22
2.2 Power Transmitter design requirements (PTx).....	23
<b>3 Power interface .....</b>	<b>24</b>
3.1 Power Receiver design requirements (PRx).....	24
3.1.1 Dual resonant circuit .....	27
3.1.2 Rectification circuit.....	29
3.1.3 Sensing circuits .....	29
3.1.4 Communications modulator.....	29
3.1.5 Communications demodulator.....	29
3.1.6 Output disconnect.....	29
3.1.7 Meaningful functionality .....	30
3.1.8 Shielding .....	30
3.1.9 Power consumption .....	30
3.2 Power Transmitter design requirements (PTx).....	31
3.2.1 Load step and load dump (informative) .....	31
3.2.2 Load step test procedure.....	31
3.2.3 Load dump test procedure .....	33
3.2.4 Power Receiver over-voltage protection.....	36
<b>4 Thermal interface .....</b>	<b>43</b>
4.1 Interface Surface temperature rise.....	43
<b>5 Information interface.....</b>	<b>44</b>
5.1 System Control.....	44
5.1.1 Overview (informative) .....	44
5.1.2 Power Transmitter (PTx) perspective .....	49
5.1.3 Power Receiver (PRx) perspective.....	70
5.1.4 State diagram (informative) .....	85
5.2 Power Receiver to Power Transmitter communications interface.....	86
5.2.1 Introduction.....	86
5.2.2 Physical and data link layers (PRx to PTx).....	86
5.2.3 Logical layer (PRx to PTx).....	91

---

5.3	Power Transmitter to Power Receiver communications interface .....	106
5.3.1	Introduction.....	106
5.3.2	Physical and data link layers (PTx to PRx).....	106
5.3.3	Logical layer (PTx to PRx).....	112
<b>PART 2: Secondary Interface Definition .....</b>		<b>116</b>
<b>6</b>	<b>External Power Input (Informative) .....</b>	<b>117</b>
6.1	Available power—Extended Power Profile only .....	117
<b>7</b>	<b>Power Levels—Extended Power Profile only .....</b>	<b>118</b>
7.1	Guaranteed Power .....	118
7.2	Light load .....	118
<b>8</b>	<b>System Efficiency (Informative).....</b>	<b>119</b>
8.1	Definition .....	119
8.2	Power Transmitter efficiency.....	120
8.2.1	Baseline Power Profile.....	120
8.2.2	Extended Power Profile .....	121
8.3	Power Receiver efficiency.....	122
<b>9</b>	<b>Stand-by Power (Informative) .....</b>	<b>123</b>
9.1	Transmitter Measurement Method.....	123
<b>10</b>	<b>Object Detection (Informative) .....</b>	<b>124</b>
10.1	Resonance shift.....	124
10.2	Capacitance change .....	126
<b>11</b>	<b>Foreign Object Detection .....</b>	<b>127</b>
11.1	Introduction .....	127
11.2	Baseline Power Profile without FOD extensions.....	128
11.3	FOD based on quality factor change—FOD extensions .....	129
11.3.1	Q-factor measurement (Informative).....	130
11.3.2	Expected operation (Informative) .....	131
11.3.3	Definition of the Reference Quality Factor .....	132

---

11.4	FOD based on calibrated power loss accounting—FOD extensions .....	133
11.4.1	Introduction.....	133
11.4.2	Received Power accuracy .....	135
11.4.3	Calibration .....	136
11.5	FOD by Power Receiver (Informative) .....	139
<b>12</b>	<b>Unintentional Magnetic Field Susceptibility (Informative) .....</b>	<b>140</b>
12.1	Limits.....	140
12.2	Protection .....	140
12.3	Power Transmitter detection.....	140
<b>13</b>	<b>User Interface .....</b>	<b>141</b>
13.1	User interaction with a Base Station .....	141
13.2	User interaction with a Mobile Device .....	142
<b>Annex A</b>	<b>EMC Standards and Regulations (informative) .....</b>	<b>143</b>
A.1	EMC.....	143
A.1.1	Regulatory obligation .....	143
A.1.2	Product category .....	143
A.1.3	Applicable standards .....	143
A.2	User Exposure to Magnetic Fields (informative) .....	144
A.2.1	Introduction.....	144
A.2.2	Applicable standards .....	144
A.2.3	Measurement method .....	145
A.2.4	Limits (reference levels) .....	145
A.2.5	Intended use.....	149
A.2.6	Application notes.....	149
<b>Annex B</b>	<b>Power Receiver Localization (Informative).....</b>	<b>150</b>
B.1	Guided Positioning.....	150
B.2	Primary Coil array based Free Positioning .....	150
B.2.1	A single Power Receiver covering multiple Primary Cells.....	150
B.2.2	Two Power Receivers covering two adjacent Primary Cells .....	151
B.2.3	Two Power Receivers covering a single Primary Cell .....	152
B.3	Moving Primary Coil based Free Positioning .....	153

B.4	User-assisted positioning .....	155
B.4.1	Example 1 .....	155
B.4.2	Example 2 .....	157
<b>Annex C</b>	<b>Power Receiver design guidelines (informative).....</b>	<b>158</b>
C.1	Large-signal resonance check .....	158
C.2	Power Receiver coil design .....	159
<b>Annex D</b>	<b>Mechanical Design Guidelines (Informative).....</b>	<b>160</b>
D.1	Base Station .....	160
D.2	Mobile Device .....	160
D.3	Base Station Alignment Aid.....	161
D.4	Mobile Device Alignment Aid .....	161
<b>Annex E</b>	<b>History of Changes.....</b>	<b>162</b>

# 1 General

## 1.1 Introduction

The Wireless Power Consortium (WPC) is a worldwide organization that aims to develop and promote global standards for wireless power transfer in various application areas. A first application area, designated Power Class 0, is wireless charging of low and medium power devices, such as mobile phones and tablet computers. The Wireless Power Consortium maintains the Qi logo for this application area.

## 1.2 Scope

This document, *Parts 1 and 2: Interface Definitions*, defines the interface between a Power Transmitter and a Power Receiver, i.e. Power Class 0 Base Stations and Mobile Devices. Power Class 0 is the WPC designation for flat-surface devices, such as chargers, mobile phones, tablets, cameras, and battery packs, in the Baseline Power Profile ( $\leq 5$  W) and Extended Power Profile ( $\leq 15$  W).

### 1.2.1 Current Specification structure (introduced in version 1.2.1)

The Qi Wireless Power Transfer System for Power Class 0 Specification consists of the following documents.

- ***Parts 1 and 2: Interface Definitions*** (this document)
  - *Part 1: Primary Interface Definition*
  - *Part 2: Secondary Interface Definition*
- *Part 3: Compliance Testing*
- *Part 4: Reference Designs*

NOTE WPC publications prior to version 1.2.1 were structured differently, and are listed in Section 1.2.2 below. In particular, the Low Power and Medium Power publications were divided into separate System Description documents. Beginning with version 1.2.1, the Low Power and Medium Power System Descriptions have been merged into the Specification structure shown in this section. Additionally, the terms *Low Power* and *Medium Power* have been replaced in the current Specification by the terms *Baseline Power Profile* and *Extended Power Profile* respectively.



## 1.2.2 Earlier Specification structure (version 1.2.0 and below)

Before release 1.2.1, the Wireless Power Transfer specification comprised the following documents.

- System Description, Wireless Power Transfer, Volume I: Low Power, Part 1: Interface Definition.
- System Description, Wireless Power Transfer, Volume I: Low Power, Part 2: Performance Requirements.
- System Description, Wireless Power Transfer, Volume I: Low Power, Part 3: Compliance Testing.
- System Description, Qi Wireless Power Transfer, Volume II: Medium Power.

## 1.3 Main features of the Qi Wireless Power Transfer System

- A method of contactless power transfer from a Base Station to a Mobile Device that is based on near-field magnetic induction between coils.
- A Baseline Power Profile supporting transfer of up to about 5 W and an Extended Power Profile supporting transfer of up to about 15 W of power using an appropriate Secondary Coil (having a typical outer dimension of around 40 mm).
- Operation at frequencies in the 87...205 kHz range.
- Support for two methods of placing the Mobile Device on the surface of the Base Station:
  - Guided Positioning helps a user to properly place the Mobile Device on the surface of a Base Station. The Base Station provides power through a single or a few fixed locations on that surface.
  - Free Positioning enables arbitrary placement of the Mobile Device on the surface of a Base Station. The Base Station can provide power through any location on that surface.
- A simple communications protocol enabling the Mobile Device to take full control of the power transfer.
- Considerable design flexibility for integration of the system into a Mobile Device.
- Very low stand-by power is achievable (implementation dependent).

## 1.4 Conformance and references

### 1.4.1 Conformance

All provisions in The Qi Wireless Power Transfer System, Power Class 0 Specification are mandatory, unless specifically indicated as recommended, optional, note, example, or informative. Verbal expression of provisions in this Specification follow the rules provided in Annex H of ISO/IEC Directives, Part 2. For clarity, the word “**shall**” indicates a requirement that is to be followed strictly in order to conform to The Qi Wireless Power Transfer System, Power Class 0 Specification, and from which no deviation is permitted. The word “**should**” indicates that among several possibilities one is recommended as particularly suitable, without mentioning or excluding others, or that a certain course of action is preferred but not necessarily required, or that in the negative form a certain possibility or course of action is deprecated but not prohibited. The word “**may**” indicates a course of action permissible within the limits of The Qi Wireless Power Transfer System, Power Class 0 Specification. The word “**can**” indicates a possibility or capability, whether material, physical, or causal.

### 1.4.2 References

For undated references, the most recently published Specification applies. The most recent WPC publications can be downloaded from <http://www.wirelesspowerconsortium.com>. (See Section 1.2.1 for a list of documents included in The Qi Wireless Power Transfer System for Power Class 0 Specification.) In addition, the following documents are referenced within The Qi Wireless Power Transfer System for Power Class 0 Specification.

- Product Registration Procedure Web page<sup>1</sup> (in the WPC Web site for members, navigate to the Testing & Registration section)
- [Qi Product Registration Manual, Logo Licensee/Manufacturer](#)<sup>1</sup>
- [Qi Product Registration Manual, Authorized Test Lab](#)<sup>1</sup>
- [Power Receiver Manufacturer Codes](#)<sup>1</sup>, Wireless Power Consortium
- [The International System of Units \(SI\)](#), Bureau International des Poids et Mesures

---

<sup>1</sup> Access is restricted and requires signing in to the WPC Web site for members.

## 1.5 Definitions

Active Area	The part of the Interface Surface of a Base Station or Mobile Device through which a sufficiently high magnetic flux penetrates when the Base Station is providing power to the Mobile Device.
Base Station	A device that is able to provide near field inductive power as specified in The Qi Wireless Power Transfer System, Power Class 0 Specification. A Base Station carries a logo to visually indicate to a user that the Base Station complies with The Qi Wireless Power Transfer System, Power Class 0 Specification.
Baseline Power Profile	The minimum set of features applying to Power Transmitters and Power Receivers that can transfer no more than around 5 W of power.
Communications and Control Unit	The functional part of a Power Transmitter or Power Receiver that controls the power transfer.  NOTE With regard to implementation, the Communications and Control Unit may be distributed over multiple subsystems of the Base Station or Mobile Device.
Control Point	The combination of voltage and current provided at the output of the Power Receiver, and other parameters that are specific to a particular Power Receiver implementation.
Detection Unit	The functional part of a Power Transmitter that detects the presence of a Power Receiver on the Interface Surface.
Digital Ping	The application of a Power Signal in order to detect and identify a Power Receiver.
Extended Power Profile	The minimum set of features applying to Power Transmitters and Power Receivers that can transfer power above 5 W.
Free Positioning	A method of positioning a Mobile Device on the Interface Surface of a Base Station that does not require the user to align the Active Area of the Mobile Device to the Active Area of the Base Station.
Foreign Object	Any object that is positioned on the Interface Surface of a Base Station, but is not part of a Mobile Device.

---

**Foreign Object Detection**

A process that a Power Transmitter or Power Receiver executes in order to determine if a Foreign Object is present on the Interface Surface.

**Friendly Metal** A part of a Base Station or a Mobile Device in which a Power Transmitter's magnetic field can generate eddy currents.

**Guaranteed Power** The amount of output power of an appropriate reference Power Receiver that the Power Transmitter ensures is available at any time during the power transfer phase. For Power Transmitters that comply with the Baseline Power Profile, the reference is TPR#1A, which is defined in *Part 3: Compliance Testing*. For Power Transmitters that comply with the Extended Power Profile, the reference is TPR#MP1B, which is also defined in *Part 3: Compliance Testing*.

Depending on the context, *Guaranteed Power* can refer to the Guaranteed Power value contained in the Power Transfer Contract, or it can refer to the Guaranteed Power Value field contained in the Power Transmitter Capability Packet.

**Guided Positioning** A method of positioning a Mobile Device on the Interface Surface of a Base Station that provides the user with feedback to properly align the Active Area of the Mobile Device to the Active Area of the Base Station.

**Interface Surface** The flat part of the surface of a Base Station that is closest to the Primary Coil(s), or the flat part of the surface of the Mobile Device that is closest to the Secondary Coil.

**Maximum Power** The maximum amount of power that a Power Receiver expects to provide at its output throughout the power transfer phase. The Maximum Power serves as a scaling factor for the Received Power Values that a Power Receiver reports in its Received Power Packets.

**Mobile Device** A device that is able to consume near field inductive power as specified in The Qi Wireless Power Transfer System, Power Class 0 Specification. A Mobile Device carries a logo to visually indicate to a user that the Mobile Device complies with the Specification.

**Operating Frequency**

The oscillation frequency of the Power Signal.

**Operating Point** The combination of the frequency, duty cycle, and amplitude of the voltage that is applied to the Primary Cell.

**Packet** A data structure for communicating a message from a Power Receiver to a Power Transmitter or vice versa. A Packet consists of a preamble, a header byte, a message, and a checksum. A Packet is named after the kind of message that it contains.

---

Potential Power	The amount of output power by an appropriate reference Power Receiver that the Power Transmitter can make available during the power transfer phase. For Power Transmitters that comply with the Baseline Power Profile, the reference is TPR#1A, which is defined in <i>Part 3: Compliance Testing</i> . For Power Transmitters that comply with the Extended Power Profile, the reference is TPR#MP1B, which is also defined in <i>Part 3: Compliance Testing</i> .
Power Conversion Unit	The functional part of a Power Transmitter that converts electrical energy to a Power Signal.
Power Factor	The ratio of the active power consumed and the apparent power drawn. The active power is expressed in watts. The apparent power typically is expressed in volt-amperes (VA).
Power Pick-up Unit	The functional part of a Power Receiver that converts a Power Signal to electrical energy.
Power Receiver	The subsystem of a Mobile Device that acquires near field inductive power and controls its availability at its output, as defined in The Qi Wireless Power Transfer System, Power Class 0 Specification. For this purpose, the Power Receiver communicates its power requirements to the Power Transmitter.
Power Signal	The oscillating magnetic flux that is enclosed by a Primary Cell and possibly a Secondary Coil.
Power Transfer Contract	A set of boundary conditions on the parameters that characterize the power transfer from a Power Transmitter to a Power Receiver. Violation of any of these boundary conditions causes the power transfer to abort.
Power Transmitter	The subsystem of a Base Station that generates near field inductive power and controls its transfer to a Power Receiver, as defined in The Qi Wireless Power Transfer System, Power Class 0 Specification.
Primary Cell	A single Primary Coil or a combination of Primary Coils that are used to provide a sufficiently high magnetic flux through the Active Area.
Primary Coil	A component of a Power Transmitter that converts electric current to magnetic flux.

Received Power	The total amount of power dissipated inside a Mobile Device, due to the magnetic field generated by a Power Transmitter. The Received Power includes the power that the Power Receiver makes available at its output for use by the Mobile Device, any power that the Power Receiver uses for its own purposes, as well as any power that is lost within the Mobile Device.
Reference Quality Factor	The quality-factor of Test Power Transmitter #MP1's Primary Coil at an Operating Frequency of 100 kHz, with a Power Receiver positioned on the Interface Surface and no Foreign Object nearby.
Response	A sequence of eight consecutive bi-phase modulated bits transmitted by a Power Transmitter in response to a request from a Power Receiver.
Secondary Coil	The component of a Power Receiver that converts magnetic flux to electromotive force.
Shielding	A component in the Power Transmitter that restricts magnetic fields to the appropriate parts of the Base Station, or a component in the Power Receiver that restricts magnetic fields to the appropriate parts of the Mobile Device.
Specification	The set of documents, Parts 1 through 4, that comprise The Qi Wireless Power Transfer System, Power Class 0 Specification (see Section 1.2.1).
Transmitted Power	The total amount of power generated by the Power Transmitter that is dissipated from the magnetic field outside the enclosure of the Base Station. The Power Transmitter typically determines the Transmitted Power by measuring the amount of power it draws from its power source and subtracting an estimate of the losses inside the enclosure of the Base Station.
WPID	A 48-bit number that uniquely identifies a Qi-compliant device.

## 1.6 Acronyms

AC	Alternating Current
ACK	Acknowledge
AWG	American Wire Gauge
BPP	Baseline Power Profile
BSUT	Base Station Under Test
CEP	Control Error Packet
DC	Direct Current
DCR	Direct Current Resistance
EM	Electro Magnetic
EMC	Electro Magnetic Compatibility
EMF	Electro Magnetic Fields
EPP	Extended Power Profile
EPT	End Power Transfer
ESR	Equivalent Series Resistance
FET	Field Effect Transistor
FOD	Foreign Object Detection
FSK	Frequency-Shift Keying
GPV	Guaranteed Power Value
LSB	Least Significant Bit
MSB	Most Significant Bit
MDUT	Mobile Device Under Test
N.A.	Not Applicable
NAK	Not-Acknowledge

ND	Not-Defined
PID	Proportional Integral Differential
PRx	Power Receiver
PPV	Potential Power Value
PTC-GP	Power Transfer Contract – Guaranteed Power
PTx	Power Transmitter
RMS	Root Mean Square
TP	Transmitter Power
TPR	Test Power Receiver
UART	Universal Asynchronous Receiver Transmitter
USB	Universal Serial Bus
WPID	Wireless Power Identifier



## 1.7 Symbols

$C_d$	Capacitance parallel to the Secondary Coil [nF]
$C_m$	Capacitance in the impedance matching network [nF]
$C_p$	Capacitance in series with the Primary Coil [nF]
$C_s$	Capacitance in series with the Secondary Coil [nF]
$d$	Duty cycle of the inverter in the Power Transmitter
$d_s$	Distance between a coil and its Shielding [mm]
$d_z$	Distance between a coil and the Interface Surface [mm]
$f_{CLK}$	Communications bit rate [kHz]
$f_d$	Resonant detection frequency [kHz]
$f_{op}$	Operating Frequency [kHz]
$f_s$	Secondary resonance frequency [kHz]
$I_m$	Primary Coil current modulation depth [mA]
$I_o$	Power Receiver output current [mA]
$I_p$	Primary Coil current [mA]
$L_m$	Inductance in the impedance matching network [ $\mu$ H]
$L_p$	Primary Coil self inductance [ $\mu$ H]
$L_s$	Secondary Coil self inductance (Mobile Device away from Base Station) [ $\mu$ H]
$L'_s$	Secondary Coil self inductance (Mobile Device on top of Base Station) [ $\mu$ H]
$P_{FO}$	Power loss that results in heating of a Foreign Object [W]
$P_{PR}$	Total amount of power received through the Interface Surface [W]
$P_{PT}$	Total amount of power transmitted through the Interface Surface [W]
$Q$	Quality factor
$t_{delay}$	Power Control Hold-off Time [ms]

$t_{\text{CLK}}$	Communications clock period [ $\mu\text{s}$ ]
$t_{\text{T}}$	Maximum transition time of the communications [ $\mu\text{s}$ ]
$V_{\text{r}}$	Rectified voltage [V]
$V_{\text{o}}$	Power Receiver output voltage [V]

## 1.8 Conventions

This section defines the notations and conventions used in The Qi Wireless Power Transfer System, Power Class 0 Specification.

### 1.8.1 Cross references

Unless indicated otherwise, cross references to sections include the sub sections contained therein.

### 1.8.2 Informative text

Informative text is set in italics, unless the complete Section is marked as informative.

### 1.8.3 Terms in capitals

Terms having a specific meaning in the context of The Qi Wireless Power Transfer System, Power Class 0 Specification are capitalized and defined in Section 1.5.

### 1.8.4 Units of physical quantities

Physical quantities are expressed in units of the International System of Units.

### 1.8.5 Decimal separator

The decimal separator is a period.

### 1.8.6 Notation of numbers

- Real numbers are represented using the digits 0 to 9, a decimal point, and optionally an exponential part. In addition, a positive and/or negative tolerance indicator may follow a real number. Real numbers that do not include an explicit tolerance indicator, are accurate to half the least significant digit that is specified.

EXAMPLE A specified value of  $1.23^{+0.01}_{-0.02}$  comprises the range from 1.21 through 1.24; a specified value of  $1.23^{+0.01}$  comprises the range from 1.23 through 1.24; a specified value of  $1.23_{-0.02}$  comprises the range from 1.21 through 1.23; a specified value of 1.23 comprises the range from 1.225 through 1.234999...; and a specified value of  $1.23^{\pm 10\%}$  comprises the range from 1.107 through 1.353.

- Integer numbers in decimal notation are represented using the digits 0 to 9.
- Integer numbers in hexadecimal notation are represented using the hexadecimal digits 0 to 9 and A to F, and are prefixed by “0x” unless explicitly indicated otherwise.
- Single bit values are represented using the words ZERO and ONE.
- Integer numbers in binary notation and bit patterns are represented using sequences of the digits 0 and 1, which are enclosed in single quotes (e.g. ‘01001’). In a sequence of  $n$  bits, the most significant bit (MSB) is bit  $b_{n-1}$  and the least significant bit (LSB) is bit  $b_0$ . The most significant bit is shown on the left-hand side.
- Numbers that are shown between parentheses are informative.

### 1.8.7 Bit ordering in a byte

The graphical representation of a byte is such that the most significant bit is on the left, and the least significant bit is on the right. Figure 1 defines the bit positions in a byte.

**Figure 1. Bit positions in a byte**

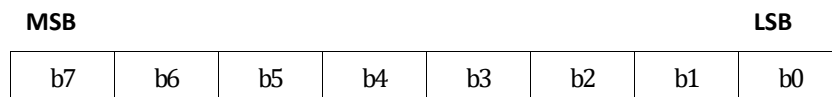

### 1.8.8 Byte numbering

The bytes in a sequence of  $n$  bytes are referred to as  $B_0, B_1, \dots, B_{n-1}$ . Byte  $B_0$  corresponds to the first byte in the sequence; byte  $B_{n-1}$  corresponds to the last byte in the sequence. The graphical representation of a byte sequence is such that  $B_0$  is at the upper left-hand side, and byte  $B_{n-1}$  is at the lower right-hand side.

### 1.8.9 Multiple-bit fields

Multiple-bit fields are used in the ID Packet. Unless indicated otherwise, a multiple-bit field in a data structure represents an unsigned integer value. In a multiple-bit field that spans multiple bytes, the MSB of the multiple-bit field is located in the byte with the lowest address, and the LSB of the multiple-bit field is located in the byte with the highest address.

NOTE Figure 2 provides an example of a 10-bit field that spans two bytes.

**Figure 2. Example of multiple-bit field**

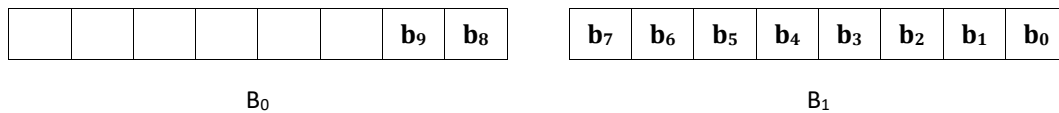

## 1.9 Operators

This section defines less-commonly used operators that are used in The Qi Wireless Power Transfer System, Power Class 0 Specification. The commonly used operators have their usual meaning.

### 1.9.1 Exclusive-OR

The symbol ‘ $\oplus$ ’ represents the exclusive-OR operation.

### 1.9.2 Concatenation

The symbol ‘||’ represents the concatenation of two bit strings. In the resulting concatenated bit string, the MSB of the right-hand side operand directly follows the LSB of the left-hand side operand.

## 1.10 Measurement equipment

All measurements shall be performed using equipment that has a resolution of at least one quarter of the precision of the quantity that is to be measured, unless indicated otherwise.

EXAMPLE “ $t_{\text{start}}=15 \text{ ms}$ ” means that the equipment shall be precise to 0.25 ms.

# **PART 1: Primary Interface Definition**

## 2 Mechanical interface

### 2.1 Power Receiver design requirements (PRx)

A Power Receiver design shall include a Secondary Coil, and an Interface Surface as defined in Section 2.1.1. In addition, a Power Receiver design shall include an alignment aid as defined in Section 2.1.2.

#### 2.1.1 Interface Surface

The distance from the Secondary Coil to the Interface Surface of the Mobile Device (see Figure 3) shall not exceed  $d_z = 2.5$  mm across the bottom face of the Secondary Coil.

**Figure 3. Secondary Coil assembly**

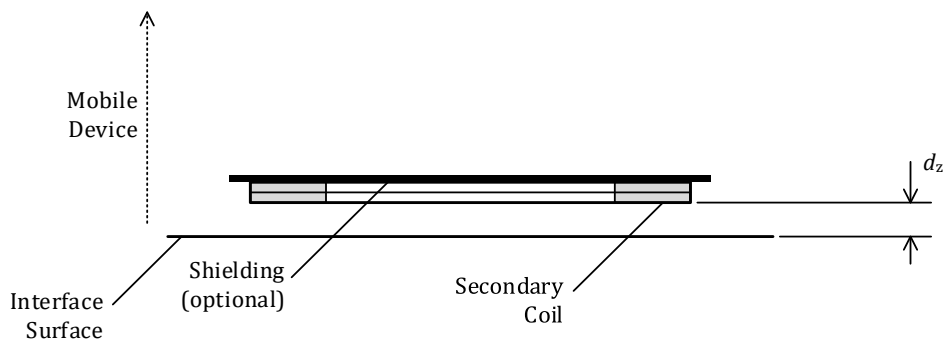

#### 2.1.2 Alignment Aid

The design of a Mobile Device shall include means that helps a user to properly align the Secondary Coil of its Power Receiver to the Primary Coil of a Power Transmitter that enables Guided Positioning. This means shall provide the user with directional guidance, i.e. to where the user should move the Mobile Device, as well as alignment indication, i.e. feedback that the user has reached a properly aligned position.<sup>2</sup>

**NOTE** The Mobile Device cannot rely on the presence of any alignment support from the Base Station other than the alignment aids specified in *Part 4: Reference Designs*.

<sup>2</sup> The design requirements of the Mobile Device determine the range of lateral displacements that constitute proper alignment.

## 2.2 Power Transmitter design requirements (PTx)

The design requirements for each Power Transmitter type are defined in *Part 4: Reference Designs*. However, there are some general concepts about Power Transmitters that are useful to know in this part of the specification.

1. The amount of Transmitted Power is limited by:
  - the design of the Power Transmitter and Power Receiver
  - the capability of the power source that the Power Transmitter operates from
  - environmental conditions, such as temperature and RF interference
2. This version 1.2.3 of the Power Class 0 Specification defines two power levels:
  - 5 W (Baseline Power Profile), which is verified using Test Power Receiver #1A-E
  - 15 W (Extended Power Profile), which is verified using Test Power Receiver #MP1A-C

Additional power levels, such as 10 W or 30 W, may be defined in future revisions of this specification.

### 3 Power interface

#### 3.1 Power Receiver design requirements (PRx)

Figure 4 illustrates an example of a functional block diagram for a Baseline Power Profile Power Receiver.

**Figure 4. Functional block diagram for a Baseline Power Profile Power Receiver**

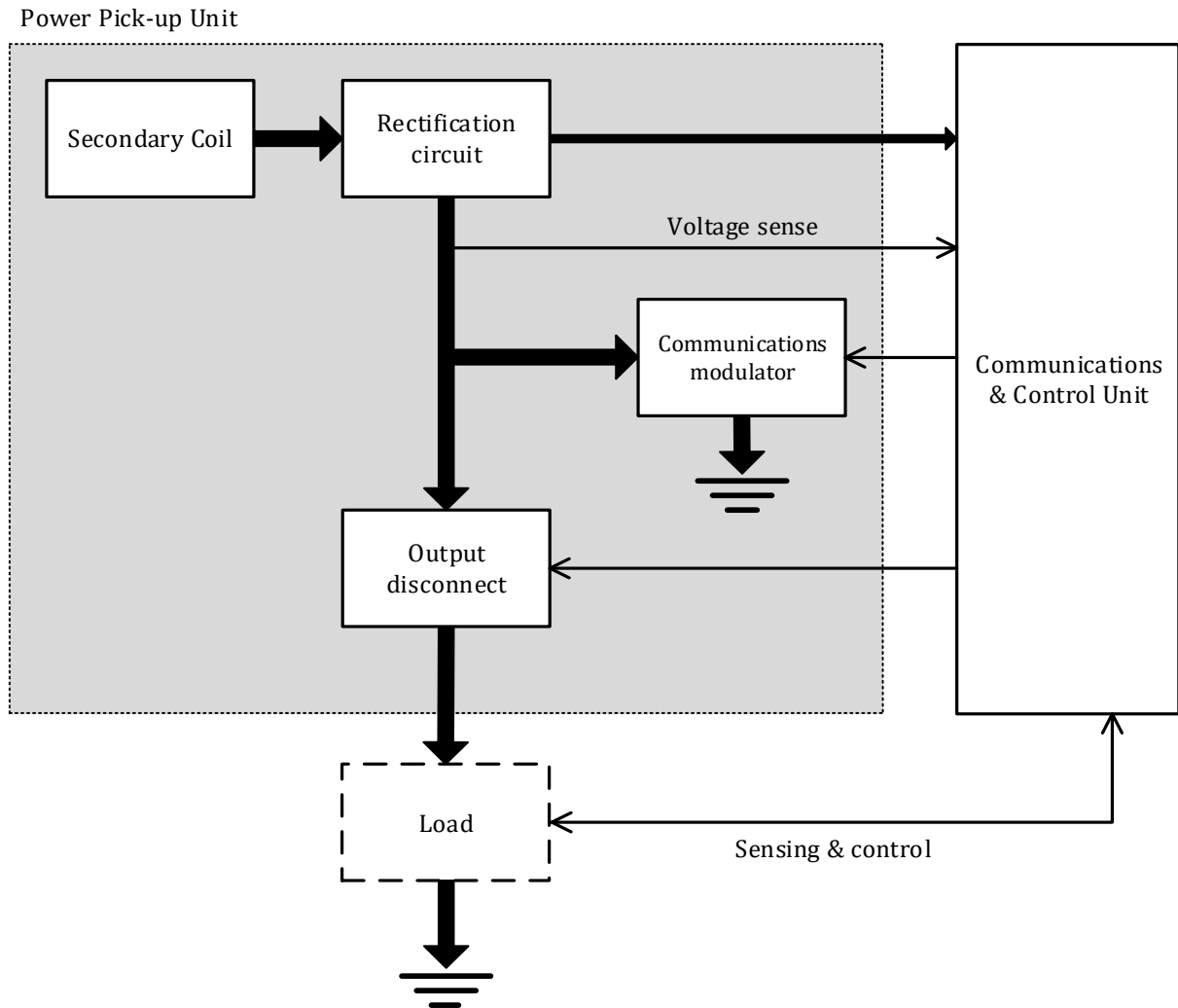



In this example, the Power Receiver consists of a Power Pick-up Unit and a Communications and Control Unit. The Power Pick-up Unit on the left-hand side of Figure 4 comprises the analog components of the Power Receiver:

- A dual resonant circuit consisting of a Secondary Coil plus series and parallel capacitances to enhance the power transfer efficiency and enable a resonant detection method (see Section 3.1.1, *Dual resonant circuit*).
- A rectification circuit that provides full-wave rectification of the AC waveform using, for example, four diodes in a full-bridge configuration or a suitable configuration of active components (see Section 3.1.2, *Rectification circuit*). The rectification circuit may perform output smoothing as well. In this example, the rectification circuit provides power to both the Communications and Control Unit of the Power Receiver and the output of the Power Receiver
- A communications modulator (see Section 3.1.4, *Communications modulator*). On the DC side of the Power Receiver, the communications modulator typically consists of a resistor in series with a switch. On the AC side of the Power Receiver, the communications modulator typically consists of a capacitor in series with a switch (not shown in Figure 4).
- An output disconnect switch, which prevents current from flowing to the output when the Power Receiver does not provide power at its output. In addition, the output disconnect switch prevents current backflow into the Power Receiver when the Power Receiver does not provide power at its output. Moreover, the output disconnect switch minimizes the power that the Power Receiver draws from the Power Transmitter when a Power Signal is first applied to the Secondary Coil.
- A rectified voltage sense.

The Communications and Control Unit on the right-hand side of Figure 4 comprises the digital logic part of the Power Receiver. This unit executes the relevant power control algorithms and protocols, drives the communications modulator, controls the output disconnect switch, and monitors several sensing circuits in both the Power Pick-up Unit and the load. (A good example of a sensing circuit in the load is a circuit that measures the temperature of a rechargeable battery.)

NOTE This version of the Specification minimizes the set of Power Receiver design requirements defined in this section. Accordingly, compliant Power Receiver designs that differ from the sample functional block diagram shown in Figure 4 are possible. For example, an alternative design includes post-regulation of the output of the rectification circuit (e.g., by using a buck converter, battery charging circuit, power management unit, etc.). In yet another design, the Communications and Control Unit interfaces with other subsystems of the Mobile Device, e.g. for user interface purposes.

Figure 5 illustrates an example of a functional block diagram for an Extended Power Profile Power Receiver. The communications demodulator enables the communication of data from the Power Transmitter to an Extended Power Profile Power Receiver. The presence of a communications demodulator is the only difference with the functional block diagram of a Baseline Power Profile Power Receiver.

**Figure 5. Functional block diagram for an Extended Power Profile Power Receiver**

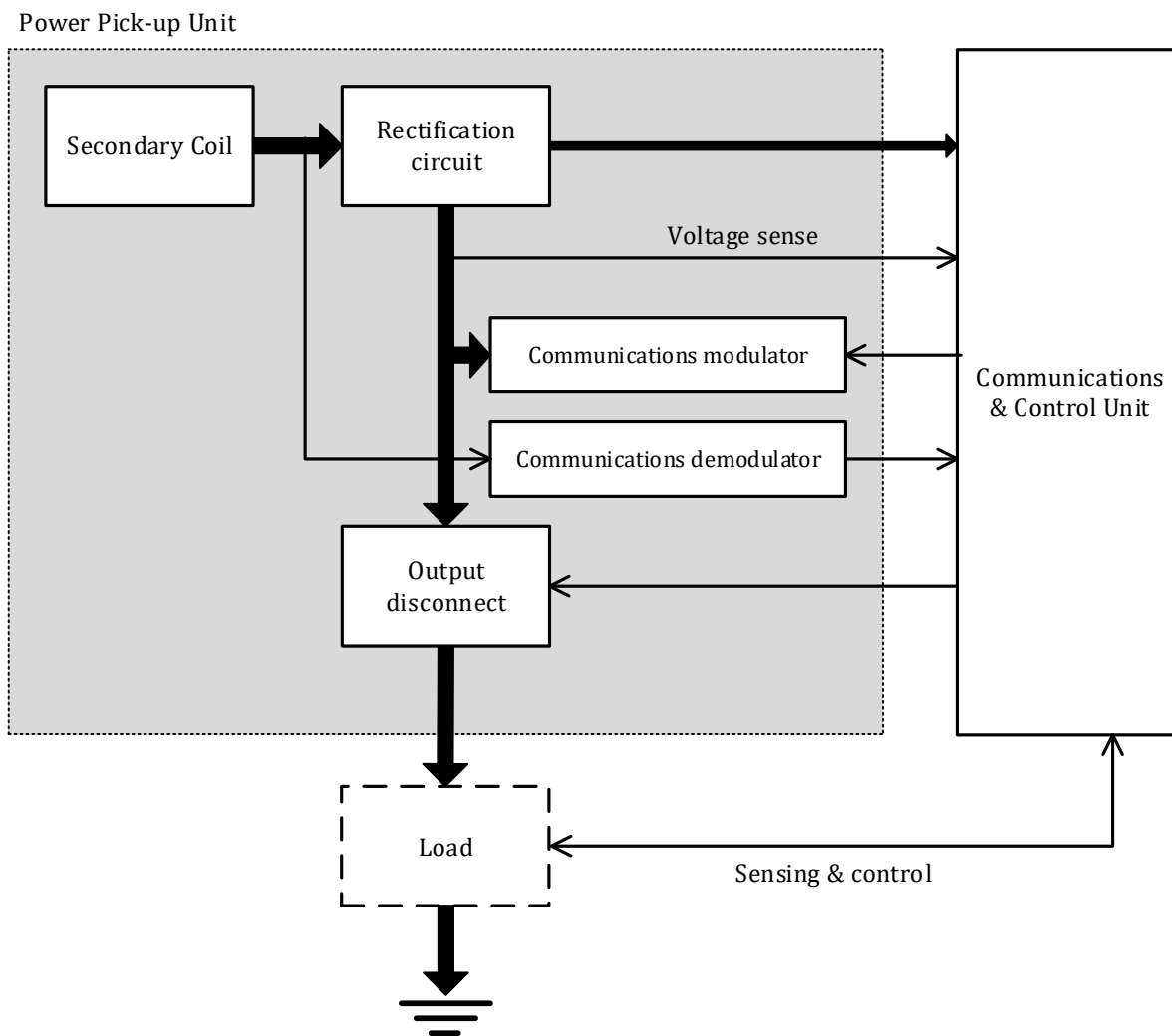

Power Pick-up Unit components are described in the subsections below.

A Power Receiver design shall include a dual resonant circuit as defined in Section 3.1.1, a rectification circuit as defined in Section 3.1.2, sensing circuits as defined in Section 3.1.3, a communications modulator as defined in Section 3.1.4, and an output disconnect switch as defined in Section 3.1.6.

A Power Receiver design for the Extended Power Profile shall also include a communications demodulator as defined in Section 3.1.5, and shall be able to function meaningfully if the Power Transmitter restrictions limit the output of power from the Power Receiver to 5 W; see Section 3.1.7.

### 3.1.1 Dual resonant circuit

The dual resonant circuit of the Power Receiver comprises the Secondary Coil and two resonant capacitances. The purpose of the first resonant capacitance  $C_s$  is to enhance the power transfer efficiency. The purpose of the second resonant capacitance  $C_d$  is to enable a resonant detection method.

Figure 6 illustrates the dual resonant circuit. The switch in the dual resonant circuit is optional. If the switch is not present, the capacitance  $C_d$  shall have a fixed connection to the Secondary Coil  $L_s$ . If the switch is present, it shall remain closed<sup>3</sup> until the Power Receiver transmits its first Packet (see Section 5.1.3.1).

**Figure 6. Dual resonant circuit of a Power Receiver**

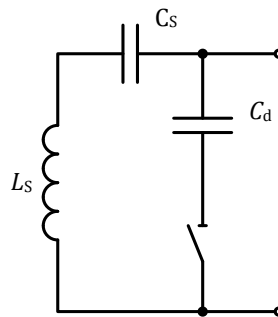

The dual resonant circuit shall have the following resonant frequencies:

$$f_s = \frac{1}{2\pi \cdot \sqrt{L'_s \cdot C_s}} = 100^{+x}_{-y} \text{ kHz},$$

$$f_d = \frac{1}{2\pi \cdot \sqrt{L_s \cdot \left(\frac{1}{C_s} + \frac{1}{C_d}\right)^{-1}}} = 1000^{\pm 10\%} \text{ kHz}.$$

In these equations,  $L'_s$  is the self inductance of the Secondary Coil when placed on the Interface Surface of a Power Transmitter and—if necessary—aligned to the Primary Cell; and  $L_s$  is the self inductance of the Secondary Coil without magnetically active material that is not part of the Power Receiver design close to the Secondary Coil (e.g. away from the Interface Surface of a Power Transmitter). Moreover, the tolerances  $x$  and  $y$  on the resonant frequency  $f_s$  are  $x = y = 5\%$  for Power Receivers that specify a Maximum Power value in the Configuration Packet of 3 W and above, and  $x = 5\%$  and  $y = 10\%$  for all other Power Receivers. The quality factor  $Q$  of the loop consisting of the Secondary Coil, switch (if

<sup>3</sup> The switch shall remain closed even if no power is available from the Secondary Coil.

present), resonant capacitance  $C_s$  and resonant capacitance  $C_d$ , shall exceed the value 77. Here the quality factor  $Q$  is defined as:

$$Q = \frac{2\pi \cdot f_d \cdot L_s}{R}$$

where  $R$  is the DC resistance of the loop with the capacitances  $C_s$  and  $C_d$  short-circuited.

Figure 7 shows the environment that is used to determine the self-inductance  $L'_s$  of the Secondary Coil. The primary Shielding shown in Figure 7 consists of material PC44 from TDK Corp. The primary Shielding has a square shape with a side of 50 mm and a thickness of 1 mm. The center of the Secondary Coil and the center of the primary Shielding shall be aligned. The distance from the Receiver Interface Surface to the primary Shielding is  $d_z = 3.4$  mm. Shielding on top of the Secondary Coil is present only if the Receiver design includes such Shielding. Other Mobile Device components that influence the inductance of the Secondary Coil shall be present as well when determining the resonant frequencies—the magnetic attractor shown in Figure 7 is an example of such a component. The excitation signal that is used to determine  $L_s$  and  $L'_s$  shall have an amplitude of 1 V RMS and a frequency of 100 kHz.

**Figure 7. Characterization of resonant frequencies**

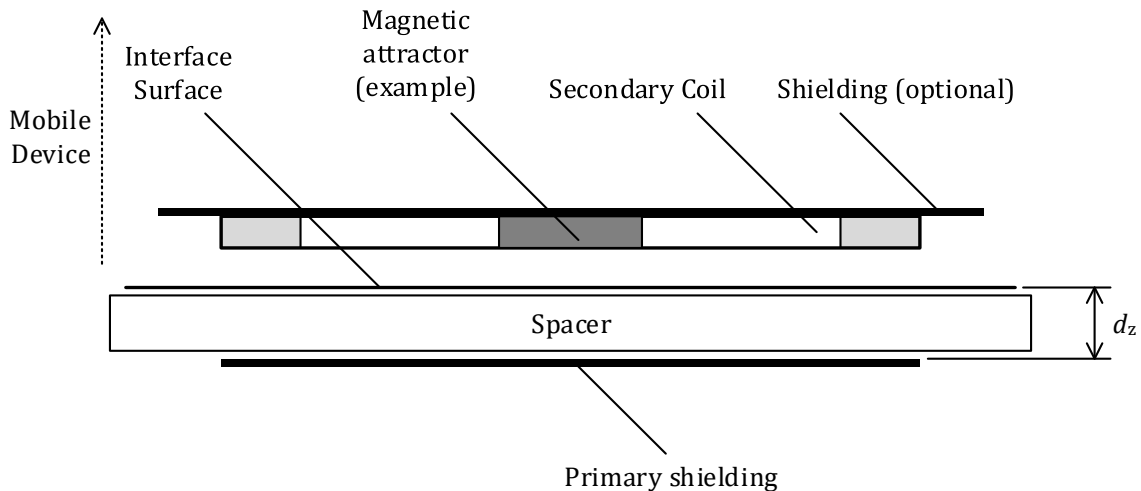

### 3.1.2 Rectification circuit

The rectification circuit shall use full-wave rectification to convert the AC waveform to a DC power level.

### 3.1.3 Sensing circuits

The Power Receiver shall monitor the DC voltage  $V_r$  directly at the output of the rectification circuit.

### 3.1.4 Communications modulator

The Power Receiver shall have the means to modulate the Primary Cell current and Primary Cell voltage as defined in Section 5.3.2.1, *Modulation scheme*.<sup>4</sup> This version of the Specification leaves the specific loading method as a design choice to the Power Receiver. Typical methods include modulation of a resistive load on the DC side of the Power Receiver and modulation of a capacitive load on the AC side of the Power Receiver.

### 3.1.5 Communications demodulator

For the Extended Power Profile or for the Baseline Power Profile with FOD extensions, the Power Receiver shall have the means to demodulate frequency-shift keying (FSK) data from the Power Signal frequency as defined in Section 5.3.2.1, *Modulation scheme*. This Specification leaves the specific method up to the designer of the Power Receiver.

### 3.1.6 Output disconnect

The Power Receiver shall have the means to disconnect its output from the subsystems connected thereto. If the Power Receiver has disconnected its output, it shall ensure that it still draws a sufficient amount of power from the Power Transmitter, such that Power Receiver to Power Transmitter communications remain possible (see Section 5.2.2.1, *Modulation scheme*).

The Power Receiver shall keep its output disconnected until it reaches the *power transfer* phase for the first time after a Digital Ping (see Section 5.1, *System Control*). Subsequently, the Power Receiver may operate the output disconnect switch any time while the Power Transmitter applies a Power Signal.

NOTE The Power Receiver may experience a voltage peak when operating the output disconnect switch (and changing between maximum and near-zero power dissipation).

---

<sup>4</sup> NOTE The dual resonant circuit as depicted in Figure 6 does not prohibit implementation of the communications modulator directly at the Secondary Coil.

### 3.1.7 Meaningful functionality

A Power Receiver shall be able to function meaningfully if the Power Transmitter restrictions limit the output of power from the Power Receiver to 5 W. Meaningful functionality includes:

- Charging a connected battery at a rate that is lower than intended.
- Providing a clear and unambiguous indication to the user that the Power Receiver cannot draw the amount of power from the Power Transmitter that it needs to function properly. See Section 13.2, *User interaction with a Mobile Device*.

NOTE The following are cases in which the Power Receiver cannot provide a desired amount of power greater than 5 W to its output.

- The Power Receiver is positioned on a Baseline Power Profile Power Transmitter (see the Power Transmitter designs in *Part 4: Reference Designs*).
- The Power Transmitter is powered by an external power supply that is designed to provide no more than 5 W of power.

### 3.1.8 Shielding

An important consideration for a Power Receiver designer is the impact of the Power Transmitter's magnetic field on the Mobile Device. Stray magnetic fields could interact with the Mobile Device and potentially cause its intended functionality to deteriorate, or cause its temperature to increase due to the power dissipation of generated eddy currents.

It is recommended to limit the impact of magnetic fields by means of Shielding on the top face of the Secondary Coil, as shown in Figure 3. This Shielding should consist of material that has parameters similar to the materials listed in *Part 4: Reference Designs*. The Shielding should cover the Secondary Coil completely. Additional Shielding beyond the outer diameter of the Secondary Coil might be necessary depending upon the impact of stray magnetic fields.

NOTE The Power Receiver design examples discussed in *Part 4: Reference Designs* include Shielding.

### 3.1.9 Power consumption

In consideration of compliance testing (see *Part 3: Compliance Testing*), a Power Receiver shall not drive the Transmitted Power of Test Power Transmitter #2 above 6500 mW or above the minimum of  $P_{\max} + 2500$  mW and 7500 mW, where  $P_{\max}$  is calculated as defined in Section 5.2.3.7, with the Power Receiver being positioned on TPT#2 such that power transfer can be sustained without interruption.

## 3.2 Power Transmitter design requirements (PTx)

### 3.2.1 Load step and load dump (informative)

A Mobile Device may perform load steps and dumps that are beyond the control of its Power Receiver. A load step or dump causes an immediate impedance change, which is reflected from the Secondary Coil to the Primary Coil and results in a change of the rectified voltage. Due to the latency of the control loop (which is mainly due to the time that is required to communicate Control Error Packets), it takes a while before the rectified voltage is readjusted to a (new) desired value. The Power Transmitter should ensure that the established Power Transfer Contract is not terminated during such an event. Therefore, an implementation of a Power Transmitter—following one of the designs defined in *Part 4: Reference Designs*—should meet load steps from 10% to 100% of the Maximum Power (as communicated by the Power Receiver in the Configuration Packet) and load dumps from 100% to 10%.

### 3.2.2 Load step test procedure

#### 3.2.2.1 Baseline Power Profile load step test

The following procedure is recommended to verify that the Power Transmitter contained in a Base Station is able to handle load steps and dumps:

3. Position Test Power Receiver #1 in configuration B on the Interface Surface of the Base Station with an initial load of  $32\ \Omega$ , a Power Control Hold-off Time of  $t_{\text{delay}} = 100\ \text{ms}$ , and an interval time between consecutive Control Error Packets of  $t_{\text{interval}} = 250\ \text{ms}$ .
4. Establish communication and regulate the rectified voltage to  $V_r = 7^{\pm 2\%}\ \text{V}$ .
5. Change the load from its initial value to  $127\ \Omega$  and regulate the rectified voltage to  $V_r = 7^{\pm 2\%}\ \text{V}$ .
6. Change the load from  $127\ \Omega$  to  $10\ \Omega$ ,  $\Delta t_1 = 50\ \text{ms}$  before a sending a Control Error Packet.
7. Verify that the Test Power Receiver continues to regulate and that the Base Station responds to the Control Error Packets by adjusting  $V_r$ .
8. Measure the rectified voltage ( $V_0$ ,  $V_1$ , and  $V_{\text{min}}$ ) with timings as shown in Figure 8, where  $\Delta t_2 = 1800\ \text{ms}$ .
9. Verify that the measured values comply with the limits provided in Table 1.

**Figure 8. Load step test diagram**

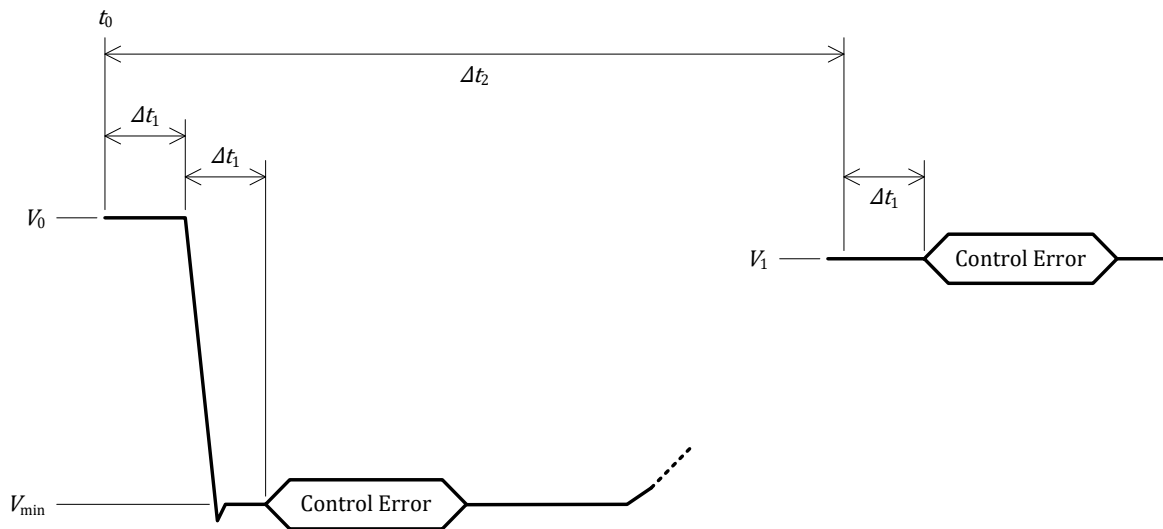

**Table 1. Load step limits**

Voltage	Minimum	Target	Maximum	Unit
$V_0$	6.9	7.0	7.1	V
$V_{min}$	4.0	7.0	7.1	V
$V_1$	6.0	$V_0$	7.1	V

### 3.2.2.2 Extended Power Profile load step test

1. Position the Test Power Receiver on the Interface Surface of the Base Station, with an initial load of  $R_{init}$ , a Power Control Hold-off Time of  $t_{delay} = 100$  ms, and an interval time between consecutive Control Error Packets of  $t_{interval} = 250$  ms. See Table 2 for relevant parameters.
2. Establish communications and regulate the rectified voltage to  $V_r$ .
3. Change the load from its initial value to  $R_{light}$  and regulate the rectified voltage  $V_r$ .
4. Change the load from  $R_{light}$  to  $R_{heavy}$  at  $\Delta t_1 = 50$  ms before a sending a Control Error Packet.
5. Verify that the Test Power Receiver continues to regulate and that the Base Station responds to the Control Error Packets by adjusting  $V_r$ .
6. Measure the rectified voltages  $V_0$ ,  $V_1$ , and  $V_{min}$  with timings as shown in Figure 8 above, where  $\Delta t_2 = 1800$  ms.
7. Verify the measured values with the limits provided in Table 1.



**Table 2. Load step definitions**

Test Power Receiver	Initial Load $R_{init}$	Light Load $R_{light}$	Heavy Load $R_{heavy}$	Rectified Voltage $V_r$
TPR#1B	32 $\Omega$	127 $\Omega$	10 $\Omega$	7 $\pm$ 2% V
TPR#MP1B	72 $\Omega$	96 $\Omega$	10 $\Omega$	12 $\pm$ 2% V

**Table 3. Load step limits**

Test Power Receiver	Voltage	Minimum [V]	Target [V]	Maximum [V]
TPR#1B	$V_0$	6.9	7.0	7.1
	$V_{min}$	4.0	7.0	7.1
	$V_1$	6.0	$V_0$	7.1
TPR#MP1B	$V_0$	11.8	12.0	12.2
	$V_{min}$	6.9	12.0	12.2
	$V_1$	10.3	$V_0$	12.2

### 3.2.3 Load dump test procedure

#### 3.2.3.1 Baseline Power Profile load dump test

1. Position Test Power Receiver #1 in configuration B on the Interface Surface of the Base Station, with an initial load of 32  $\Omega$ , a Power Control Hold-off Time  $t_{delay} = 100$  ms, and an interval time between consecutive Control Error Packets  $t_{interval} = 250$  ms.
2. Establish communication and regulate the rectified voltage to  $V_r = 7\pm 2\%$  V.
3. Change the load from its initial value to 10  $\Omega$  and regulate the rectified voltage to  $V_r = 7\pm 2\%$  V.
4. Change the load from 10  $\Omega$  to 127  $\Omega$ ,  $\Delta t_1 = 50$  ms before a sending a Control Error Packet.
5. Verify that the Test Power Receiver continues to regulate and that the Base Station responds to the Control Error Packets by adjusting  $V_r$ .
6. Measure the rectified voltage ( $V_0$ ,  $V_1$ , and  $V_{min}$ ) with timings as shown in Figure 9. Load dump test diagram, where  $\Delta t_2 = 1800$  ms.
7. Verify that the measured values comply with the limits provided in Table 4.

**Figure 9. Load dump test diagram**

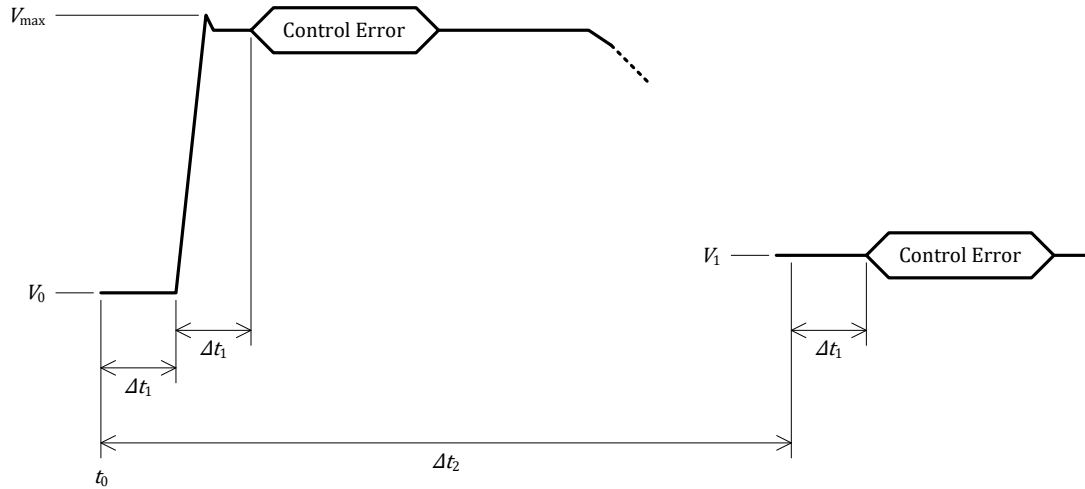

**Table 4. Load dump limits (Baseline Power Profile)**

Voltage	Minimum	Target	Maximum	Unit
$V_0$	6.9	7.0	7.1	V
$V_{min}$	6.9	7.0	12.0	V
$V_1$	6.9	$V_0$	8.0	V

### 3.2.3.2 Extended Power Profile load dump test

- Position the Test Power Receiver on the Interface Surface of the Base Station, with an initial load of  $R_{init}$ , a Power Control Hold-off Time of  $t_{delay} = 100$  ms, and an interval time between consecutive Control Error Packets of  $t_{interval} = 250$  ms. See Table 5 for the relevant parameters.
- Establish communications and regulate the rectified voltage to  $V_r$ .
- Change the load from its initial value to  $R_{heavy}$  and regulate the rectified voltage  $V_r$ .
- Change the load from  $R_{heavy}$  to  $R_{light}$  at  $\Delta t_1 = 50$  ms before a sending a Control Error Packet.
- Verify that the Test Power Receiver continues to regulate and that the Base Station responds to the Control Error Packets by adjusting  $V_r$ .
- Measure the rectified voltages  $V_0$ ,  $V_1$ , and  $V_{min}$  with timings as shown in Figure 9 above, where  $\Delta t_2 = 1800$  ms.
- Verify the measured values with the limits provided in Table 5.

**Table 5. Load dump definitions (Extended Power Profile)**

Test Power Receiver	Initial Load $R_{init}$	Light Load $R_{light}$	Heavy Load $R_{heavy}$	Rectified Voltage $V_r$
TPR#1B	32 $\Omega$	127 $\Omega$	10 $\Omega$	7 $\pm$ 2% V
TPR#MP1B	72 $\Omega$	96 $\Omega$	10 $\Omega$	12 $\pm$ 2% V

**Table 6. Load dump limits**

Test Power Receiver	Voltage	Minimum [V]	Target [V]	Maximum [V]
TPR#1B	$V_0$	6.9	7.0	7.1
	$V_{min}$	6.9	7.0	12.0
	$V_1$	6.9	$V_0$	8.0
TPR#MP1B	$V_0$	11.8	12.0	12.2
	$V_{min}$	11.8	12.0	20.5
	$V_1$	11.8	$V_0$	13.7

### 3.2.4 Power Receiver over-voltage protection

A Power Transmitter shall limit the amplitude of its Power Signal (or magnetic field strength) such that it does not generate a rectified voltage higher than 20 V at the output of a properly designed Power Receiver.

NOTE: Examples of properly designed Power Receivers are provided in *Part 4: Reference Designs*. In addition, the set of Test Power Receivers defined in *Part 3: Compliance Testing* are also examples of properly designed Power Receivers.

The Power Signal depends on the amount of current that runs through the Primary Coil. This amount is primarily determined by the Power Transmitter's Operating Point, the Power Receiver's load impedance, and the coupling between the Primary Coil and Secondary Coil. Whereas the Power Receiver can—to a certain extent—control its load impedance and the Power Transmitter's Operating Point by transmitting appropriate Control Error Packets, it has little control over the coupling. As a consequence, scenarios exist in which a higher-than-expected voltage can result at the Power Receiver's output.

In one scenario the user initially places the Power Receiver at a position where the coupling is poor and subsequently moves it to a position where the coupling is strong. In practice this can happen when the user keeps the Power Receiver hovering at a small distance above the Interface Surface before setting it down, or when the user places the Power Receiver with a large misalignment between the Primary Coil and Secondary Coil and subsequently slides it into better alignment.

In either case, the Power Transmitter can detect the Power Receiver and establish communications before the coils are properly aligned. The Power Receiver can then start to control its output voltage to a higher level, such as 12 V, in order to prepare for connecting its load. If the coupling is poor, the Power Receiver typically can reach its target voltage only by driving the power Transmitter to use a high Primary Coil current (and therefore a strong Power Signal or high magnetic field). If the coupling suddenly improves substantially, as in the above scenarios, the Power Receiver does not have time to drive the Power Transmitter back to a lower Primary Coil current. As a result, its output voltage can substantially increase—up to tens of volts if no special precautions are taken.

Many Power Receiver implementations that are based on common IC technology cannot handle such voltages, with 20 V being a safe upper limit. Moreover, design constraints often are of such a nature that commonly used solutions for over-voltage protection cannot be applied. For example, large Zener diodes or dummy loads that can handle the excess power typically are too bulky to fit in space-limited designs. Accordingly, the Power Receiver typically has no alternative but to rely on the Power Transmitter to keep its voltage below the safe limit.

Whereas a Power Transmitter can hold its Primary Coil current to a sufficiently low level, placing a hard limit on the Primary Coil current can prevent a Power Receiver from reaching its target power level when it has connected its load. A better solution is to define more than one limit according to the amount of power that is transmitted: the Power Transmitter should use a low current limit if the Transmitted Power is low to prevent an over-voltage from occurring in the Power Receiver, and it should use a high current limit if the Transmitted Power is high to enable the Power Receiver to reach its target Operating Point without creating an over-voltage in the Power Receiver. The system model and analysis below explain this approach in more detail.

Figure 10 illustrates a simplified model of the system comprising a Power Transmitter on the left and a Power Receiver on the right. For clarity, the load circuit is drawn separately from the Power Receiver. The Power Transmitter consists of a power source ( $u_{op}, f_{op}$ ), a capacitance  $C_p$ , an inductance  $L_p$ , and a resistance  $R_p$ . The power source supplies a sinusoidal voltage  $u_{op}$  at a frequency  $f_{op}$ . The Power Receiver consists of a capacitance  $C_s$ , an inductance  $L_s$ , and a resistance  $R_s$ . A load having an impedance  $Z_L$  is connected to the output terminals of the Power Receiver. The symbols  $u_L$ ,  $i_L$ ,  $i_p$ , and  $k_{op}$  represent the load voltage, load current, Primary Coil current, and coupling factor.

**Figure 10. Simplified system model**

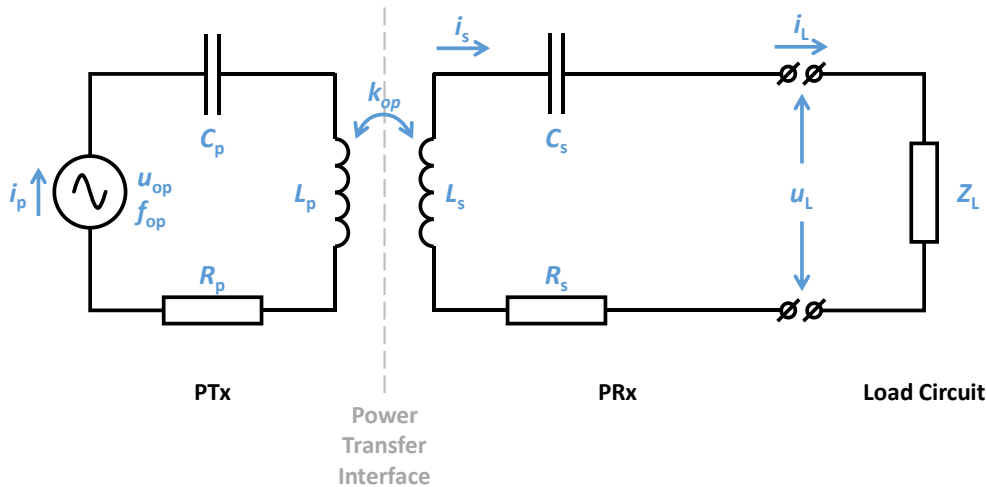

For simplicity the Power Receiver in the model includes neither a rectifier nor a resonance at a frequency  $f_d$  as defined in Sections 3.1.2 and 3.1.1. The absence of the additional resonance does not significantly affect the results discussed below. The effect of the rectifier is described at the end of this section.

Table 7 lists the parameters associated with the system model in Figure 10. Instead of the resonant capacitances  $C_p$  and  $C_s$ , and the resistances  $R_p$  and  $R_s$ , the resonant frequencies  $f_p$  and  $f_s$ , and quality factors  $Q_p$  and  $Q_s$  are provided. The relations between these parameters are as follows:

$$f_p = \frac{1}{2\pi\sqrt{L_p C_p}}, \quad f_s = \frac{1}{2\pi\sqrt{L_s C_s}}, \quad Q_p = \frac{2\pi f_p L_p}{R_p}, \quad Q_s = \frac{2\pi f_s L_s}{R_s}$$

The Power Transmitter controls the amount of power it transfers by adjusting the amplitude of its voltage and frequency in the ranges given in Table 7. At start-up, it uses the ping voltage  $u_{\text{ping}}$  and ping frequency  $f_{\text{ping}}$ . To control the power up, it decreases its frequency while keeping its voltage constant at the maximum value. To control the power down, it increases the frequency at constant voltage, and after reaching the maximum frequency value decreases the voltage while keeping the frequency constant at that maximum.

At start-up, the Power Receiver uses a load impedance  $Z_{\text{ping}}$ , which represents the load of its control electronics such as a microprocessor. After start-up, the Power Receiver can adjust its load impedance to reach its target Operating Point as given by the target voltage  $u_L$  and target current  $i_L$ .

**Table 7. Parameters of the simplified model**

Power Transmitter			Power Receiver		
$L_p$	25	$\mu\text{H}$	$L_s$	35	$\mu\text{H}$
$f_p$	100	kHz	$f_s$	100	kHz
$Q_p$	100		$Q_s$	40	
$u_{\text{op}}$	2...24	V (pk)	$u_L$	12	V (rms)
$f_{\text{op}}$	100...200	kHz	$i_L$	1.5	A (rms)
$u_{\text{ping}}$	24	V (pk)	$Z_L$	0.1...1000	$\Omega$
$f_{\text{ping}}$	175	kHz	$Z_{\text{ping}}$	800	$\Omega$

Power Transmitter operation is subject to these constraints:

- The PTx only uses the part of its operating frequency range where the Primary Coil current decreases while the operating frequency increases. This constraint ensures that the Control Error Packets from the Power Receiver have a consistent effect: a positive Control Error Value causes the Primary Coil current to increase, and a negative Control Error Value causes the Primary Coil current to decrease.

NOTE: A positive Control Error Value directs the Power Transmitter to increase its voltage, or to decrease its operating frequency if the voltage has reached its maximum value. A negative Control Error Value directs the Power transmitter to increase its operating frequency, or to decrease its voltage if the operating frequency has reached its maximum value. This method of power control is used by many of the Power Transmitter designs provided in *Part 4: Reference Designs*.

- The PTx limits the amount of power that it takes from its power source. In the simplified model, the maximum average power is 24 W.

- The PTx limits the amount of Primary Coil current. Two examples are discussed below. In the first example, the Primary Coil current is limited at the fixed value of 3 A rms. In the second example, the Primary Coil current limit depends on the Transmitted Power, increasing from 0.75 A (rms) at near zero Transmitted Power up to about 2.7 A (rms) at near maximum Transmitted Power.

The diagram on the left in Figure 11 illustrates the full operating space of the Power Transmitter in terms of its Primary Coil current and the power it takes from its power source. The diagram on the right illustrates the operating space of the Power Receiver in terms of its load current and voltage. The solid black lines in the Power Transmitter’s diagram indicate its power and current limits. The solid black dot in the Power Receiver’s diagram indicates its target Operating Point. The colors of the different curves represent different coupling factors. The red curve corresponds to a coupling factor of 0.56 (good coupling). The yellow, green, blue, and purple curves correspond to 80%, 60%, 40%, and 20% of the “red” value. Each curve forms a closed contour limiting the operating space of the Power Transmitter and Power Receiver for the associated coupling factor (for the parts of the contour that coincide with the power limit, the current limit, or the diagram axes this may be difficult to see). The Power Transmitter and Power Receiver can reach any point within a contour given appropriate values of the Power Transmitter’s operating frequency and voltage. Finally, the stars indicate the ping Operating Points of the Power Transmitter and Power Receiver.

**Figure 11. Operating space with a fixed-maximum Primary Coil current**

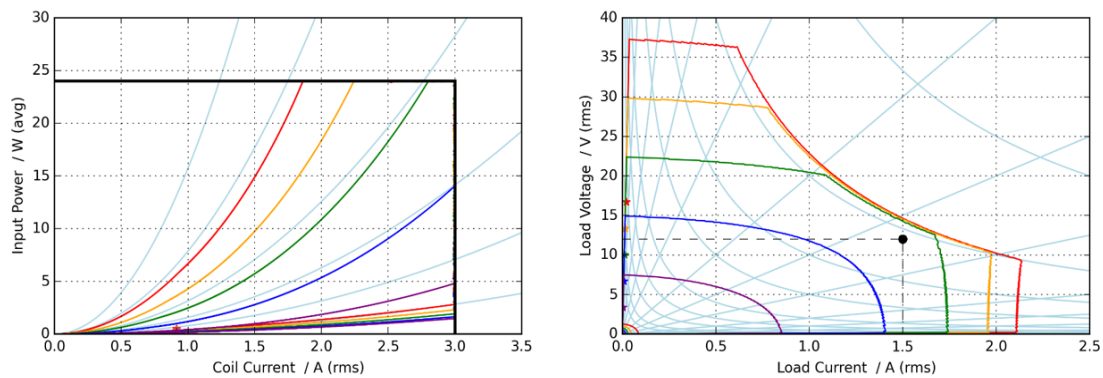

The diagram on the right shows that the Power Receiver can reach its target Operating Point for a coupling factor greater than about 0.3, because that Operating Point lies well within the green contour (a coupling factor of 60%·0.56). The diagram also makes clear that the load voltage can potentially reach levels well above 20 V (rms) for coupling factors greater than 0.3. For example, the top left corner of the yellow curve, representing a coupling factor of 80%·0.56 and a load impedance of 1 kΩ, reaches a load voltage of 30 V (rms).

The solid curves in Figure 12 illustrate the “trajectories” that the Power Transmitter and Power Receiver follow through their operating space when controlling from the ping Operating Point to the target Operating Point at different coupling factors. Each trajectory starts from the ping Operating Point, which is indicated by a star. The Power Receiver first controls its load voltage to a value just over 12 V (rms). In the Transmitter’s diagram this is the slightly slanted line near the bottom (less than 1 W of input power). In the Power Receiver it is the steep line close to the vertical axis. Next the Power Receiver changes its load from the ping load impedance to the target load impedance (12 V / 1.5 A = 8 Ω). This load step increases the Power Transmitter’s power and Primary Coil current, and it decreases the load voltage. For the lowest coupling (purple curve) the Primary coil current even exceeds the limit. In this example, the Power Transmitter does not enforce its current limit instantly, but instead controls its Operating Point back to the limit after completion of the load step. Finally, the Power Receiver controls its voltage to the target value, which is possible for the highest coupling factors only (red, yellow, and green curves). At the lower coupling factors (blue and purple curves), the Power Transmitter hits its current limit. The solid squares indicate the final Operating Point for each coupling factor.

**Figure 12. System control with a fixed-maximum Primary Coil current (1)**

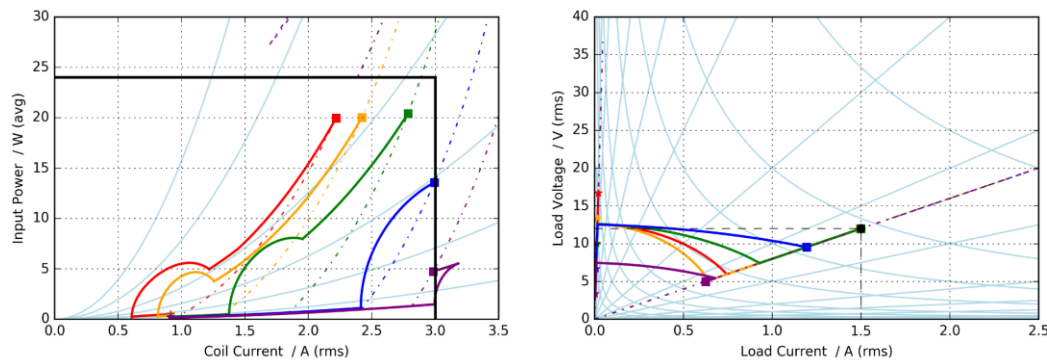

As a clear illustration of the scenarios described earlier in this section, the dashed and dotted curves in Figure 12 show the trajectories that the Power Transmitter and Power Receiver follow if the coupling factor changes between zero and 0.56. The load impedance and the Power Transmitter’s Operating Point are fixed on these trajectories (i.e. the Power Transmitter does not enforce its limits during the coupling step). As shown in the diagram on the right, the load voltage can reach values up to about 20 V (rms) at the target load impedance of 8 Ω. To reach this voltage, the input power and Primary Coil current exceed their limits substantially (see the left diagram). The behavior is radically different at the ping impedance of 800 Ω, where the load voltage can reach values well over 20 V (rms). Corresponding trajectories are not visible in the diagram on the left because the coupling step causes hardly any change in the Primary Coil current and input power. Even if the Power Transmitter would instantly enforce its limits, the load voltage would reach these high levels. This is clearly visible in Figure 13, where the maximum load voltage is much reduced at the target load impedance but not at the ping impedance. In fact, the maximum reachable load voltages can be read directly from the red contour in Figure 11 (diagram on the right).



**Figure 13. System control with a fixed-maximum Primary Coil current (2)**

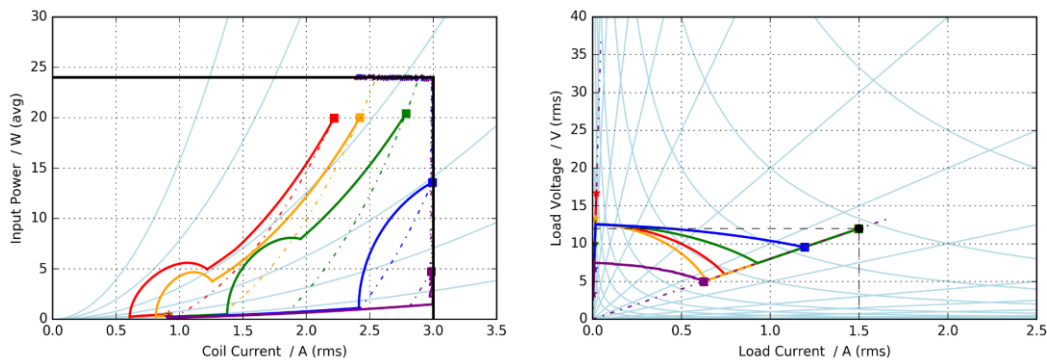
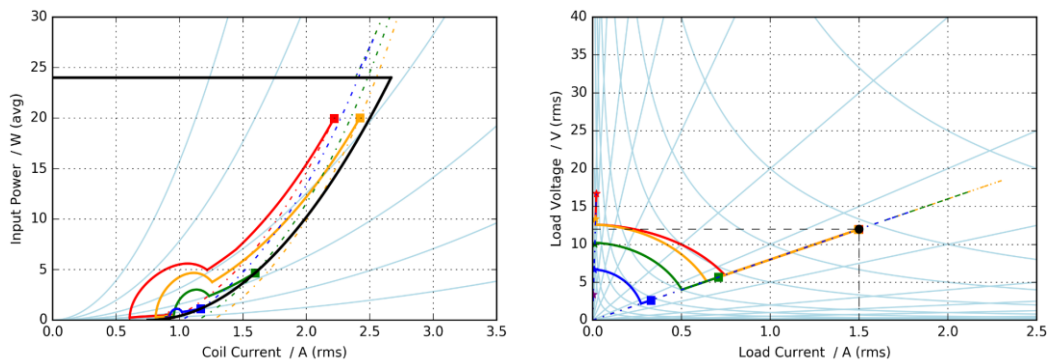

Figure 14 illustrates that a Primary Coil current limit that depends on the Transmitted Power (or on the input power) is a means to mitigate high load voltages in the Power Receiver. Clearly, the highest load voltages reached using this limit stay well below 20 V (rms). This example also illustrates that the cost of this approach is a reduced coupling range over which the Power Receiver can reach its target Operating Point (the green curve representing a coupling factor of 60%·0.56 does no longer reach the target Operating Point). This means that proper alignment of the Power Transmitter and Power Receiver becomes important. Different shapes of the current limit yield a different trade-off between maximum load voltage and the coupling range.

**Figure 14. System control at power-dependent maximum Primary Coil current (1)**



As a final example, Figure 15 illustrates the full operating space that results from the power-dependent current limit; the trajectories that result if the Power Receiver scales its power back from its target to load powers of 10 W, 5 W, and 3 W; and the maximum voltages that result from coupling steps at these additional Operating Points. In most cases, the maximum voltage does not exceed 20 V (rms), and where it does exceed 20 V (rms) it is not by much.

**Figure 15. System control at power dependent maximum Primary Coil current (2)**

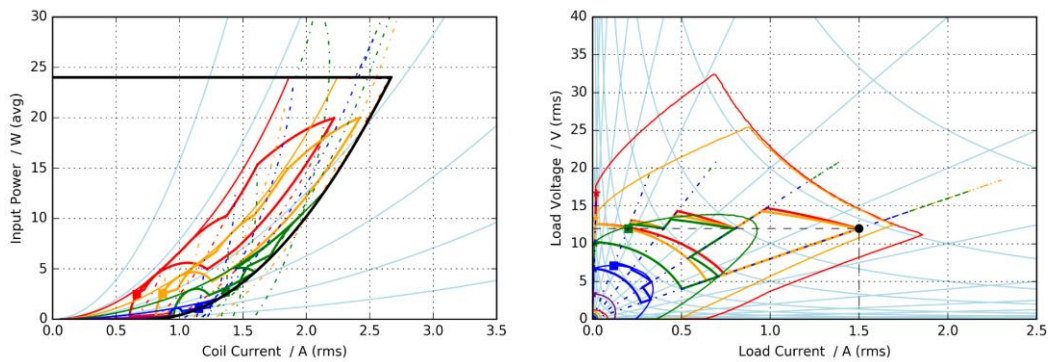

All practical Power Receiver implementations use a rectifier as part of the load circuit shown in Figure 10 (see also Section 3.1.2). Moreover, most Power Receiver implementations include a capacitor directly after this rectifier to smoothen the ripple on the rectified voltage. In combination with a high load impedance (low load current), this smoothing capacitor typically charges to a level approaching the peak voltage that is present at the input to the rectifier. When determining the appropriate (power-dependent) current limit this effect should be taken into account. Special care should be taken in designing Power Transmitters that use duty-cycle control (instead of frequency or voltage control), because the peak voltage in those designs can be substantially higher than the rms voltage that is used in the above examples. (The voltage waveform at the input to the rectifier resembles the waveform generated by the Power Transmitter’s power source.)

## 4 Thermal interface

### 4.1 Interface Surface temperature rise

The Base Station shall limit the top surface temperature of the thermal Test Power Receiver (TPR-THERMAL, defined in *Part 3: Compliance Testing*) to at most 12 °C above the ambient temperature, while TPR-THERMAL is operating at its desired Control Point for 1 hour in an environment that is shielded against spurious thermal contributions due to air flow, radiation, etc. It is recommended that the Base Station limits the Interface Surface temperature to at most 5 °C above the ambient temperature, while powering TPR-THERMAL for 1 hour.

## 5 Information interface

### 5.1 System Control

As noted in Section 1.4.2, this Power Class 0 Specification includes both the Baseline Power Profile (power transfers up to 5 W) and the Extended Power Profile (power transfers greater than 5 W). While much of the information presented in this Specification applies to both power profiles, there are some differences. Those differences are identified in this specification as they occur.

This Specification also describes FOD extensions, which use bidirectional communications and negotiation between the Power Transmitter (PTx) and Power Receiver (PRx) to enhance the options for Foreign Object Detection. Support for FOD extensions is optional in the Baseline Power Profile but mandatory in the Extended Power Profile:

- Baseline Power Profile Power Transmitters and Power Receivers **may** support the FOD extensions.
- Extended Power Profile Power Transmitters and Power Receivers **shall** support the FOD extensions.

#### 5.1.1 Overview (informative)

From a system control perspective, power transfer from a Power Transmitter to a Power Receiver comprises four phases in the Baseline Power Profile, namely *selection*, *ping*, *identification & configuration*, and *power transfer*. Figure 16 illustrates the relation between the phases. The solid arrows indicate transitions, which the Power Transmitter initiates; and the dash-dotted arrows indicate transitions that the Power Receiver initiates. By definition, if the Power Transmitter is not applying a Power Signal, the system is in the *selection* phase. This means that a transition from any of the other phases to the *selection* phase involves the Power Transmitter removing the Power Signal.

**Figure 16. Power transfer phases—Baseline Power Profile**

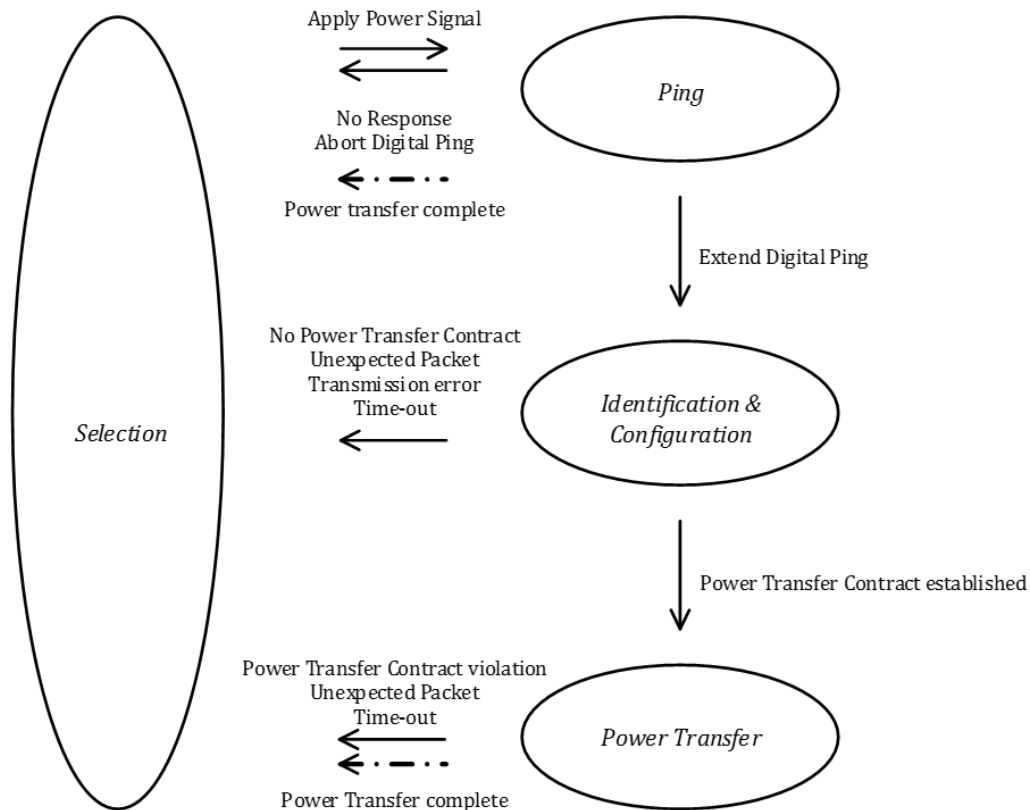

The main activity in each of these phases is the following:

- selection** In this phase, the Power Transmitter typically monitors the Interface Surface for the placement and removal of objects. The Power Transmitter may use a variety of methods for this purpose. See Section 10, *Object Detection (Informative)* for some examples. If the Power Transmitter discovers one or more objects, it should attempt to locate those objects—in particular if it supports Free Positioning. In addition, the Power Transmitter may attempt to differentiate between Power Receivers and Foreign Objects, such as keys, coins, etc. Moreover, the Power Transmitter should attempt to select a Power Receiver for power transfer. If the Power Transmitter does not initially have sufficient information for these purposes, the Power Transmitter may repeatedly proceed to the *ping* and subsequently to the *identification & configuration* phases—each time selecting a different Primary Cell—and revert to the *selection* phase after collecting relevant information. See Annex B, *Power Receiver Localization (Informative)* for examples. Finally, if the Power Transmitter selects a Primary Cell, which it intends to use for power transfer to a Power Receiver, the Power Transmitter proceeds to the *ping* phase and eventually to the *power transfer* phase. On the other hand, if the Power Transmitter does not select a Power Receiver for power transfer and is not actively providing power to a Power Receiver for an extended amount of time, the Power Transmitter should enter a stand-by mode of operation.<sup>5</sup> See Section 9 for performance requirements on such a mode of operation.

<sup>5</sup> Note that it is up to the Power Transmitter implementation to determine whether this stand-by mode of operation is part of the *selection* phase or is separate from the *selection* phase.

- *ping* In this phase, the Power Transmitter executes a Digital Ping, and listens for a response. If the Power Transmitter discovers a Power Receiver, the Power Transmitter may extend the Digital Ping, i.e. maintain the Power Signal at the level of the Digital Ping. This causes the system to proceed to the *identification & configuration* phase. If the Power Transmitter does not extend the Digital Ping, the system shall revert to the *selection* phase.
- *identification & configuration* In this phase, the Power Transmitter identifies the selected Power Receiver, and obtains configuration information such as the maximum amount of power that the Power Receiver intends to provide at its output. The Power Transmitter uses this information to create a Power Transfer Contract. This Power Transfer Contract contains limits for several parameters that characterize the power transfer in the *power transfer* phase. At any time before proceeding to the *power transfer* phase, the Power Transmitter may decide to terminate the extended Digital Ping (for example, to discover additional Power Receivers). This reverts the system to the *selection* phase.
- *power transfer* In this phase, the Power Transmitter continues to provide power to the Power Receiver, adjusting its Primary Cell current in response to control data that it receives from the Power Receiver. Throughout this phase, the Power Transmitter monitors the parameters that are contained in the Power Transfer Contract. A violation of any of the stated limits on any of those parameters causes the Power Transmitter to abort the power transfer, and returns the system to the *selection* phase. Finally, the system may also leave the *power transfer* phase on request of the Power Receiver. Section 5.1.2 defines the system control protocols in the *ping*, *identification & configuration*, and *power transfer* phases from a Power Transmitter perspective. Section 5.1.3 defines the system control protocols in these four phases from a Power Receiver perspective.

NOTE This version of the Specification does not define the system control protocol in the *selection* phase.

NOTE From a power transfer point of view, the Power Receiver remains passive throughout most of the *selection* phase.

At any time a user can remove a Mobile Device that is receiving power. The Power Transmitter can recognize such an event from a time-out in the communications from the Power Receiver, or from a violation of the Power Transfer Contract. As a result, the Power Transmitter aborts the power transfer and the system reverts to the *selection* phase.

Throughout the *power transfer* phase, the Power Transmitter and Power Receiver control the amount of power that is transferred. Figure 17 illustrates a schematic diagram of the power transfer control loop, which basically operates as follows: the Power Receiver selects a desired Control Point: a desired output current and/or voltage, a temperature measured somewhere in the Mobile Device, etc. In addition, the Power Receiver determines its actual Control Point. The Power Receiver may use any approach to determine a Control Point. Moreover, the Power Receiver may change this approach at any time during the *power transfer* phase. Using the desired Control Point and actual Control Point, the Power Receiver calculates a Control Error Value—for example, by simply taking the (relative) difference of the two output voltages or currents. The result is negative if the Power Receiver requires less power in order to reach its desired Control Point and positive if the Power Receiver requires more power in order to reach its desired Control Point. Subsequently, the Power Receiver transmits this Control Error Value to the Power Transmitter.

The Power Transmitter uses the Control Error Value and the actual Primary Cell current to determine a new Primary Cell current. After the system stabilizes from the communications of the Control Error Packet, the Power Transmitter has a short time window to control its actual Primary Cell current towards the new Primary Cell current. Within this window, the Power Transmitter reaches a new Operating Point: the amplitude, frequency, and duty cycle of the AC voltage that is applied to the Primary Cell. Subsequently, the Power Transmitter keeps its Operating Point fixed in order to enable the Power Receiver to communicate additional control and status information. For details, see Section 5.1.2.6.1, *Power transfer control*.

**Figure 17. Power transfer control loop**

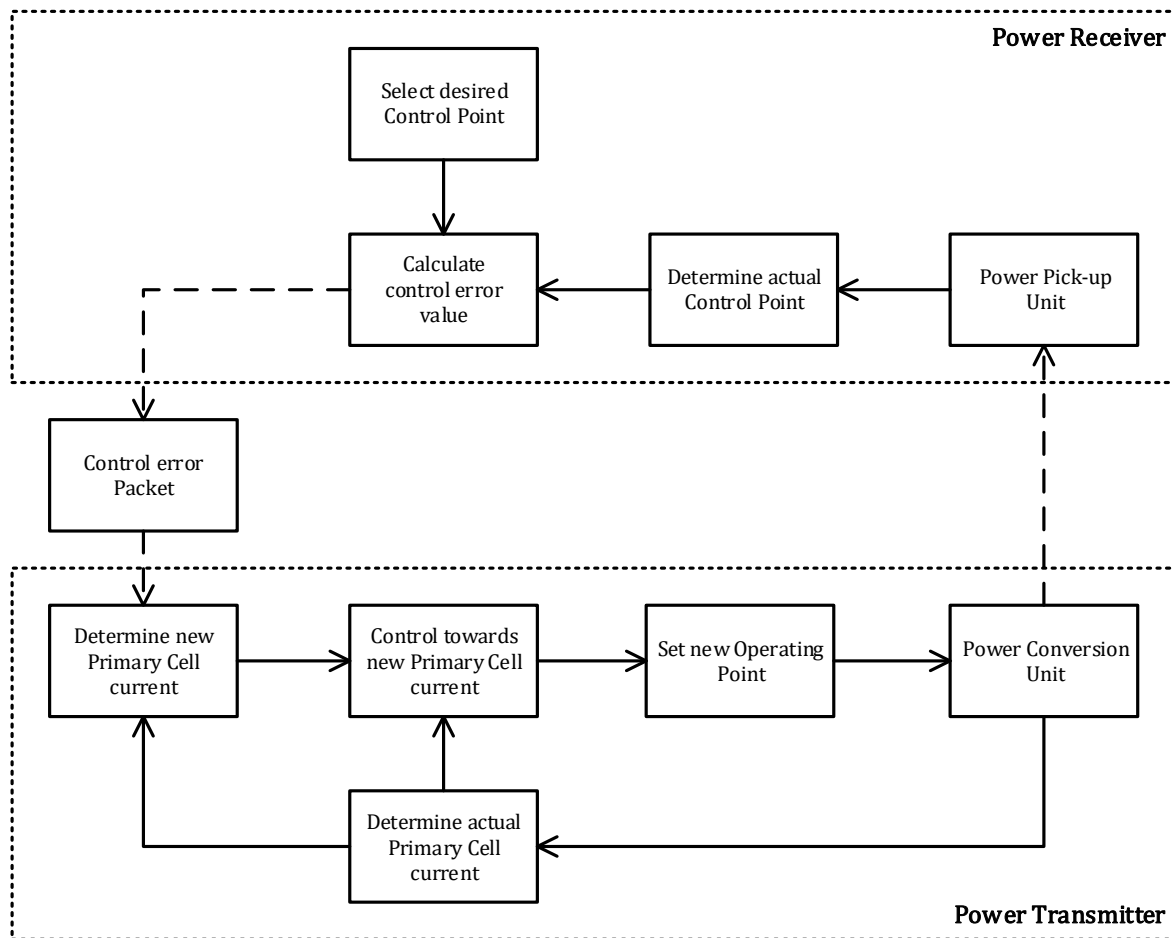

### 5.1.1.1 FOD extensions

The FOD extensions add a *negotiation* phase, a *calibration* phase, and a *renegotiation* phase to the basic system control functionality, as shown in Figure 18.

**Figure 18. Power transfer phases—Extended Power Profile**

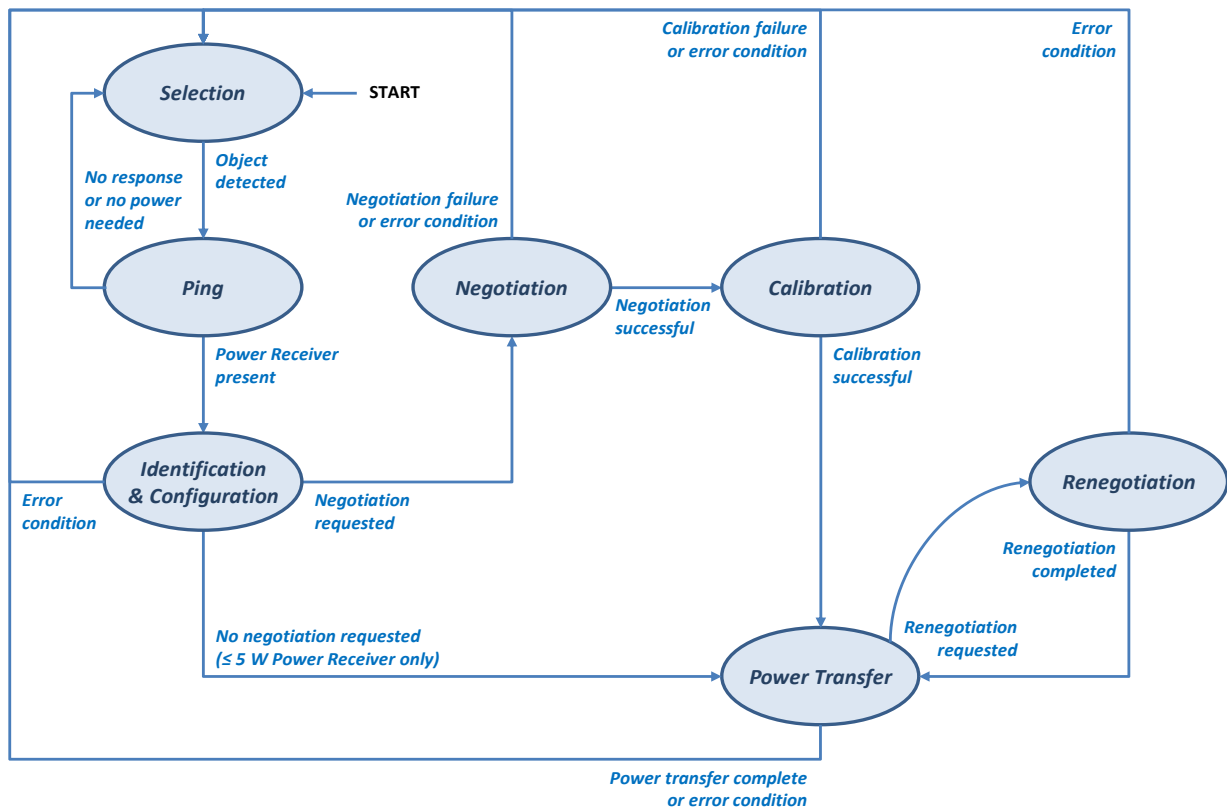

These additional phases mostly deal with improved Foreign Object Detection capabilities, as described below:

- *Selection* phase. In this phase, the Power Transmitter typically monitors the Interface Surface for the placement and removal of objects using a small measurement signal. This measurement signal should not wake up a Power Receiver that is positioned on the Interface Surface. For more details, see Section 10, *Object Detection (Informative)* and Annex B, *Power Receiver Localization (Informative)*. If the Power Transmitter detects a Foreign Object on its Interface Surface, it should stay in the *selection* phase and should not provide a Power Signal in order to avoid heating up the Foreign Object.
- *Negotiation* phase. In this phase, the Power Receiver negotiates with the Power Transmitter to fine-tune the Power Transfer Contract. For this purpose, the Power Receiver sends negotiation requests to the Power Transmitter, which the Power Transmitter can grant or deny. In addition, to improve its initial assessment of whether Foreign Objects are present, the Power Transmitter can compare the quality factor reported by the Power Receiver with its own measurement (see Section 11.3, *FOD based*



on *quality factor change*). If the Power Transmitter detects a Foreign Object, it should return to the *selection* phase.

- *Calibration* phase. In this phase, the Power Transmitter can improve its ability to detect Foreign Objects during power transfer. In particular, the Power Transmitter can adjust parameters of the power loss method (see Section 11.4, *FOD based on calibrated power loss accounting*). Hereto, the Power Receiver provides its Received Power at two different load conditions.
- *Power transfer* phase. In this phase, the Power Transmitter continues to check if new Foreign Objects have been placed on its Interface Surface. Hereto, it may use, e.g. the power loss method (see Section 11.4, *FOD based on calibrated power loss accounting*). The Power Receiver may also check for the placement of new Foreign Objects. If the Power Transmitter or the Power Receiver detects a Foreign Object, the Power Transmitter and/or the Power Receiver should either reduce the Power Signal or remove the Power Signal and return to the *selection* phase.
- *Renegotiation* phase. In this phase, the Power Receiver can make adjustments to the Power Transfer Contract, if so desired. If necessary, this phase may be aborted prematurely without changing the Power Transfer Contract.

### 5.1.2 Power Transmitter (PTx) perspective

This section defines a protocol that the Power Transmitter shall execute to transfer power to a Power Receiver. Note that three of the seven phases are applicable only to the Extended Power Profile if the Power Transmitter supports the FOD Extensions.

1. *Selection* phase. Section 5.1.2.1 defines the protocol to select a Power Receiver for the power transfer.
2. *Ping* phase. Section 5.1.2.2 defines the Digital Ping.
3. *Identification & configuration* phase. Section 5.1.2.3 defines the part of the protocol that the Power Transmitter shall execute in order to identify the Power Receiver and establish a default Power Transfer Contract. This protocol extends the Digital Ping in order to enable the Power Receiver to communicate the relevant information.
4. *Negotiation* phase (FOD extensions only). Section 5.1.2.4 defines the part of the protocol that the Power Transmitter shall execute if the Power Receiver requests to negotiate changes to the default Power Transfer Contract.
5. *Calibration* phase (FOD extensions only). Section 5.1.2.5 defines the part of the protocol that the Power Transmitter shall execute in the *calibration* phase. The Power Transmitter can use the information obtained from the Power Receiver in this phase to improve its ability to detect Foreign Objects during power transfer.
6. *Power transfer* phase. Section 5.1.2.6 defines the part of the protocol that the Power Transmitter shall execute during power transfer. In this part of the protocol, the Power Transmitter controls its Primary Cell current in response to control data received from the Power Receiver.
7. *Renegotiation* phase (FOD extensions only). Section 5.1.2.7 defines the part of the protocol that the Power Transmitter executes to update the Power Transfer Contract during power transfer.

Many provisions in Section 5.1.2 refer to the start and/or the end of a Packet, or to the start of a Packet's preamble. In the case of a Packet that is sent from the Power Receiver to the Power Transmitter:

- The start of the Packet is defined as the instant that the Power Transmitter receives the first edge of the start bit of the Packet's header byte.
- The end of the Packet is defined as the instant that the Power Transmitter receives the second edge of the stop bit of the Packet's checksum byte.
- The start of the Packet's preamble is defined as the instant that the Power Transmitter receives the first edge of the first preamble bit.

In the case of a Packet or Response that is sent from the Power Transmitter to the Power Receiver:

- The start of the Packet or Response is defined as the instant of the first zero crossing of the first Power Signal cycle in which the Operating Frequency changes in accordance with the FSK modulation requirements.
- The end of the Packet or Response is defined as the instant of the first zero crossing of the first Power Signal cycle in which the Operating Frequency changes back to the original Operating Frequency in accordance with the FSK modulation requirements. This occurs after the final transition of the Packet or Response.

If the Base Station can take its input power from a USB Micro-B or Micro-AB receptacle, the Power Transmitter can potentially not provide the requested amount of power to a Power Receiver. If a Power Receiver has made at most three unsuccessful attempts to initiate and maintain power transfer—e.g. has terminated the power transfer three times in a row with an End Power Transfer Packet—the Power Transmitter shall refrain from entering the *power transfer* phase until the Power Receiver has been removed from the Interface Surface of the Base Station.

#### 5.1.2.1 Selection phase (PTx perspective)

In the *selection* phase the Power Transmitter determines if it will proceed to the *ping* phase after detecting the placement of an object. This Specification does not define how the Power Transmitter makes this determination.

If the Base Station can take its input power from an adapter that has a lower wattage rating than the Power Transmitter's rating, the Power Transmitter may not provide the requested amount of power to a Power Receiver. If a Power Receiver has made at most three unsuccessful attempts to initiate and maintain a power transfer, the Power Transmitter shall refrain from entering the *ping* phase until the Power Receiver has been removed from the Interface Surface of the Base Station. An example of an unsuccessful attempt is when the Power Receiver has terminated the power transfer three times in a row with an End Power Transfer Packet containing an End Power Transfer Code of 0x08 (No Response) or 0x0A (Negotiation Failure).

### 5.1.2.2 Ping phase (PTx perspective)

In the *ping* phase, the Power Transmitter shall execute a Digital Ping. This Digital Ping shall proceed as follows, with conditions appearing earlier in this list taking precedence over conditions appearing later.

- The Power Transmitter shall apply a Power Signal at the Operating Point defined for the particular Power Transmitter design (see *Part 4: Reference Designs*).
- If the Power Transmitter does not detect the start of a Packet in the time window  $t_{\text{ping}}$  after the Primary Cell current amplitude reaches 50% of the stable level, the Power Transmitter shall remove the Power Signal (i.e. reduce the Primary Cell current to zero) within  $t_{\text{terminate}}$ . See Figure 19(a).
- If the Power Transmitter correctly receives a Signal Strength Packet, the Power Transmitter may proceed to the *identification & configuration* phase of the power transfer, maintaining the Power Signal at the Operating Point as defined for the particular Power Transmitter design. See Figure 19(b). If the Power Transmitter does not proceed to the *identification & configuration* phase, the Power Transmitter shall remove the Power Signal within  $t_{\text{expire}}$  after the start of the Signal Strength Packet. See Figure 19(c).
- If the Power Transmitter does not correctly receive the first Packet (see Section 5.2.2.4, *Packet structure*) within the time interval  $t_{\text{first}}$  after the start of the first Packet, the Power Transmitter shall remove the Power Signal within  $t_{\text{terminate}}$ . See Figure 19 (d).
- If the Power Transmitter correctly receives any other Packet than a Signal Strength Packet, and in particular if the Power Transmitter receives an End Power Transfer Packet, the Power Transmitter shall remove the Power Signal within  $t_{\text{terminate}}$  after the end of the Packet. See Figure 19 (e).
- If the Power Transmitter does not proceed to the *identification & configuration* phase, the Power Transmitter shall revert to the *selection* phase.

NOTE The thick line in Figure 19 represents the amplitude of the Power Signal, which is zero at the left-hand side of the diagrams. The dashed line represents possible communications from the Power Receiver, which the Power Transmitter shall ignore as a result of the above conditions.

**Figure 19. Power Transmitter timing in the ping phase**

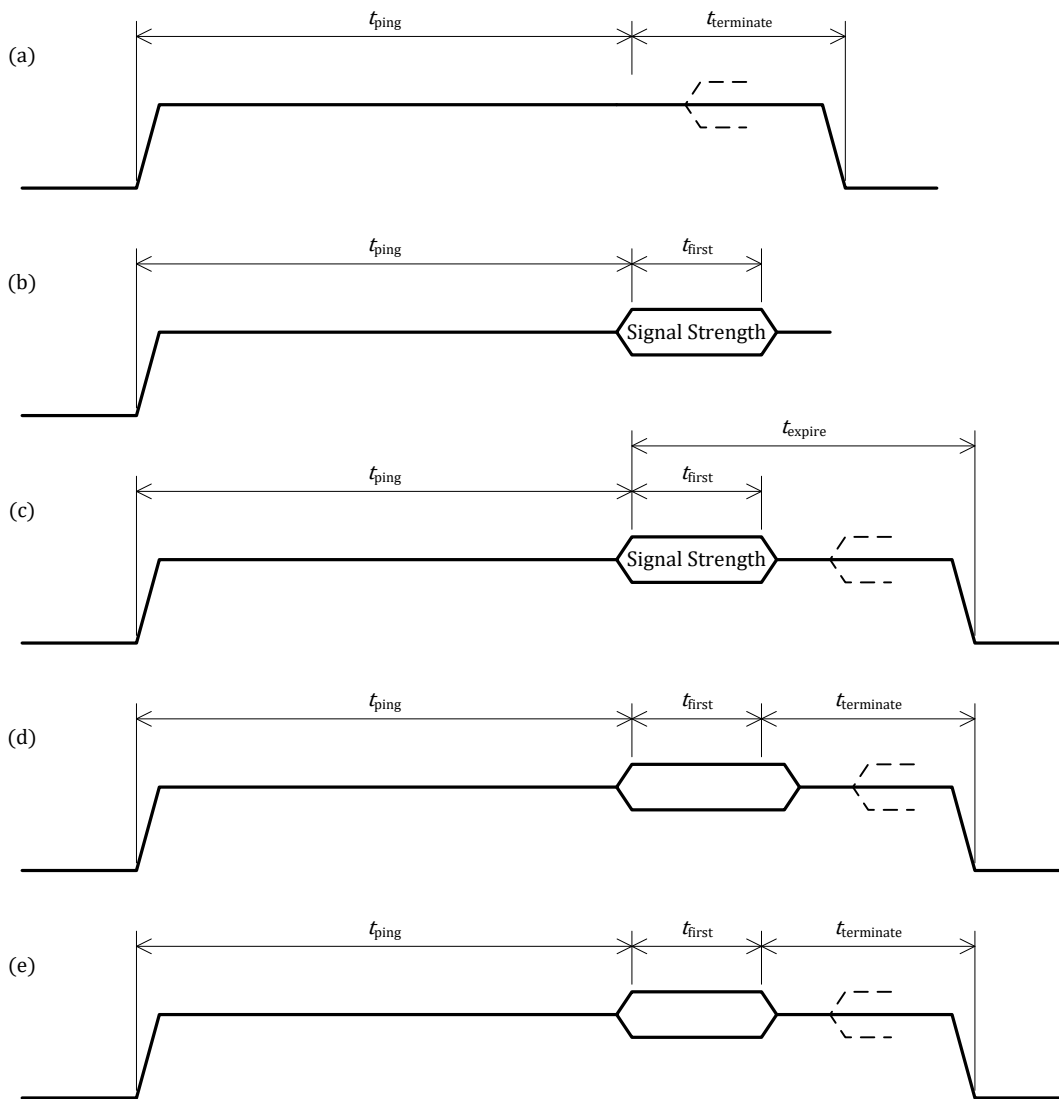

**Table 8. Power Transmitter timing in the ping phase**

Parameter	Symbol	Minimum	Target	Maximum	Unit
Digital Ping window	$t_{ping}$	65.0 <sub>-0</sub>	65	70.0 <sup>+0</sup>	ms
Power Signal termination time	$t_{terminate}$	N.A.	N.A.	28.0 <sup>+0</sup>	ms
First Packet time out	$t_{first}$	N.A.	N.A.	20.0 <sup>+0</sup>	ms
Power Signal expiration time	$t_{expire}$	N.A.	N.A.	90.0 <sup>+0</sup>	ms

### 5.1.2.3 Identification & configuration phase (PTx perspective)

In the *identification & configuration* phase, the Power Transmitter shall identify the Power Receiver and collect configuration information. For this purpose, the Power Transmitter shall correctly receive the following sequence of Packets in the order shown and without changing its Operating Point.

1. If the Power Transmitter enters the *identification & configuration* phase from the *ping* phase, an Identification Packet.
2. If the Ext bit of the preceding Identification Packet is set to ONE, an Extended Identification Packet.
3. Up to 7 optional configuration Packets from the following set (the order in which the Power Transmitter receives these Packets, if any, is not relevant):
  - A Power Control Hold-off Packet. If the Power Transmitter receives multiple Power Control Hold-off Packets, the Power Transmitter shall retain the Power Control Hold-off Time  $t_{\text{delay}}$  contained in the last Power Control Hold-off Packet received (see below).
  - Any Proprietary Packet (as listed in Table 26). If the Power Transmitter does not know how to handle the message contained in the Proprietary Packet, the Power Transmitter shall ignore that message.
  - Any reserved Packet (as indicated in Table 26). The Power Transmitter shall ignore the message contained in the reserved Packet.
4. A Configuration Packet. If the number of optional configuration Packets, which the Power Transmitter has received, is not equal to the value contained in the Count field of the Configuration Packet, the Power Transmitter shall remove the Power Signal within  $t_{\text{terminate}}$  ms after receiving the stop bit of the Configuration Packet's checksum byte, and return to the *selection* phase.

The Power Transmitter shall receive the above sequence of Packets subject to the following timing constraints:

- If the Power Transmitter does not detect the start bit of a next Packet's header byte in the sequence within the time interval  $t_{\text{next}}$  after the end of the Packet directly preceding it in the sequence, the Power Transmitter shall remove the Power Signal within  $t_{\text{terminate}}$ . See Figure 20(a). In this context, the Packet directly preceding the Identification Packet is the Signal Strength Packet, which the Power Transmitter has received in the *ping* phase.
- If the Power Transmitter does not correctly receive a Packet in the sequence within the time interval  $t_{\text{max}}$  after the start of that Packet, the Power Transmitter shall remove the Power Signal within  $t_{\text{terminate}}$ . See Figure 20(b).
- If the Power Transmitter correctly receives a next Packet that does not comply with the above sequence, the Power Transmitter shall remove the Power Signal within  $t_{\text{terminate}}$  after the end of that Packet. See Figure 20(c).

In addition to these timing constraints, if the Power Transmitter does not receive a Packet correctly (see Section 5.2.2.4, *Packet structure*), the Power Transmitter shall remove the Power Signal within  $t_{\text{terminate}}$  after detecting the error.

After the Power Transmitter has received the Configuration Packet, the Power Transmitter shall execute the following steps, in the order shown.

1. If the relation  $t_{\text{delay}}^{(\text{min})} \leq t_{\text{delay}} \leq t_{\text{delay}}^{(\text{max})}$  is not satisfied, the Power Transmitter shall revert to the *selection* phase. Moreover, if the Power Transmitter reverts to the *selection* phase, the Power Transmitter shall remove the Power Signal within  $t_{\text{terminate}}$  after the end of the Configuration Packet. If the Power Transmitter has not received a Power Control Hold-off Packet, the Power Transmitter shall proceed to use  $t_{\text{delay}} = t_{\text{delay}}^{(\text{min})}$ .
2. If the Power Transmitter has correctly received all Packets in the sequence (see Figure 20(d)), the Power Transmitter shall create a Power Transfer Contract. See below.
3. **FOD extensions not supported:** If the Power Transmitter has created a Power Transfer Contract, the Power Transmitter may proceed to the *power transfer* phase. If the Power Transmitter does not proceed to the *power transfer* phase, the Power Transmitter shall remove the Power Signal within  $t_{\text{expire}}$  after the start of the Configuration Packet. See Figure 20(e).

**FOD extensions supported:**

- If the Neg bit in the received Configuration Packet is set to ZERO, the Power Transmitter should proceed to the *power transfer* phase without sending a Response.
  - If the Neg bit in the received Configuration Packet is set to ONE, the Power Transmitter shall send an Acknowledge Response within  $t_{\text{response}}$  after the end of the received Configuration Packet (see also Section 5.2.3.7, *Configuration Packet (0x51)*). Subsequently, the Power Transmitter should proceed to the *negotiation* phase. See Figure 21.
4. **FOD extensions not supported:** If the Power Transmitter has removed the Power Signal—and does not proceed to the *power transfer* phase—the Power Transmitter shall revert to the *selection* phase.

**FOD extensions supported:** If the Power Transmitter does not proceed to the *power transfer* phase or to the *negotiation* phase, the Power Transmitter shall remove the Power Signal within  $t_{\text{expire}}$  after the start of the Configuration Packet. See Figure 20(e).

**Figure 20. Power Transmitter timing in the *identification & configuration* phase**

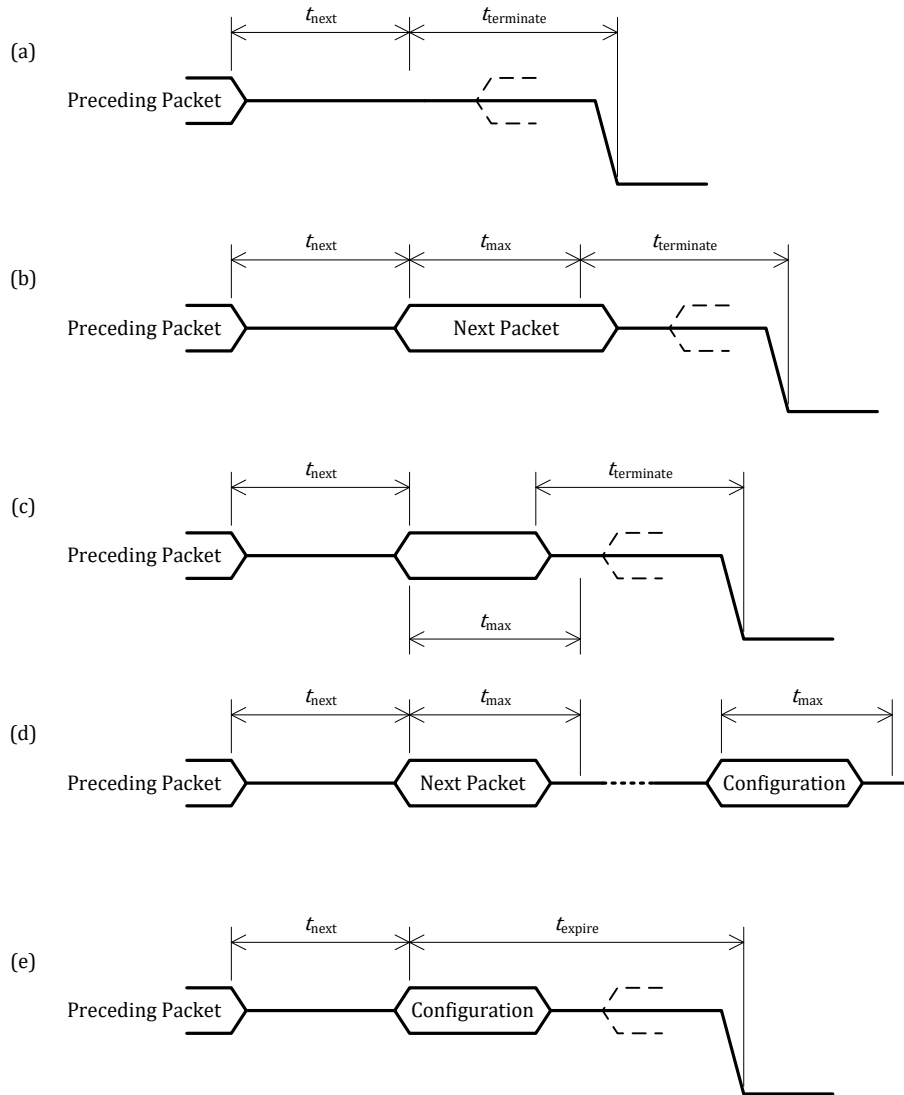

**Figure 21. Power Transmitter timing in the *identification & configuration* phase (FOD extensions)**

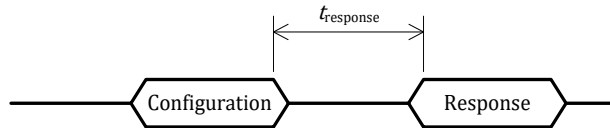

**Table 9. Power Transmitter timing in the *identification & configuration* phase**

Parameter	Symbol	Minimum	Target	Maximum	Unit
Next Packet time-out	$t_{\text{next}}$	22.0 <sub>-0</sub>	N.A.	25.0 <sup>+0</sup>	ms
Maximum Packet length	$t_{\text{max}}$	N.A.	N.A.	170.0 <sup>+0</sup>	ms
Response Time	$t_{\text{response}}$	3 <sub>-0</sub>	N.A.	10.0 <sup>+0</sup>	ms

**Table 10. Power control hold-off time**

Parameter	Symbol	Value	Unit
Power Control Hold-off Time	$t_{\text{delay}}^{(\text{min})}$	5	ms
Power Control Hold-off Time	$t_{\text{delay}}^{(\text{max})}$	205	ms

#### 5.1.2.3.1 Creating a Power Transfer Contract

**FOD extensions not supported:** Based on the configuration information received from the Power Receiver, the Power Transmitter can create a Power Transfer Contract. This version 1.2.3 of the Specification does not define the parameters that comprise a Power Transfer Contract for the Baseline Power Profile. However, it is recommended that the Power Transfer Contract contains at least the following parameter:

- The maximum power that the Power Receiver intends to provide at its output (as obtained from the Maximum Power field of the Configuration Packet).

**FOD extensions supported:** At the end of the *identification & configuration* phase, the Power Transmitter shall create a Power Transfer Contract containing the parameters shown in Table 11.

**Table 11. Initial Power Transfer Contract**

Parameter	Value
Guaranteed Power	5 W
Maximum Power	Derived from the Maximum Power Value contained in the Configuration Packet
Received Power Packet Format	Header of the 8-bit Received Power Packet (0x04)
FSK Polarity / Modulation Depth	Value contained in the Configuration Packet



### 5.1.2.4 Negotiation phase—FOD extensions only (PTx perspective)

In the *negotiation* phase, the Power Transmitter receives a series of Packets that contain requests to update the Power Transfer Contract. In response to each Packet, the Power Transmitter shall send either

- a Response to indicate whether it grants the request, denies the request, or does not recognize the request; or
- a data Packet that contains the requested information.

Prior to receiving the requests to update the Power Transfer Contract, the Power Transmitter shall create a temporary copy of the Power Transfer Contract. The Power Transmitter shall use this temporary copy to store updated parameters until successful completion of the *negotiation* phase.

#### 5.1.2.4.1 Timing constraints

After transmitting a Response or a data Packet, the Power Transmitter should extend the Digital Ping for a time interval  $t_{negotiate}$  in order to enable the Power Receiver to transmit a subsequent request. If the Power Transmitter does not receive a Packet within this time interval, it should remove the Power Signal within  $t_{terminate}$  (see Figure 22(a)).

The Power Transmitter shall start to transmit its Response or data Packet within  $t_{response}$  after the end of the Packet containing the request (see Figure 22(b)).

**Figure 22. Power Transmitter timing in the *negotiation* phase**

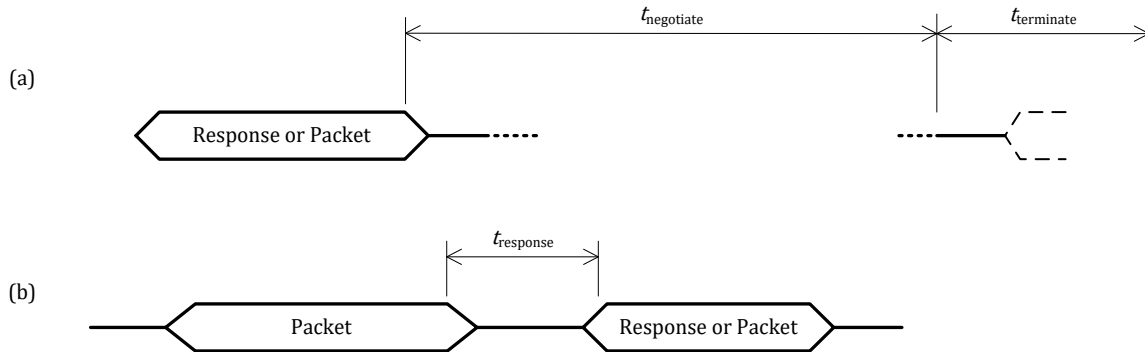

**Table 12. Power Transmitter timing in the *negotiation* phase**

Parameter	Symbol	Minimum	Target	Maximum	Unit
Next Packet time-out	$t_{negotiate}$	200 <sub>-0</sub>	N.A.	(250 <sup>+0</sup> )	ms
Response interval	$t_{response}$	3 <sub>-0</sub>	N.A.	10 <sup>+0</sup>	ms

#### 5.1.2.4.2 Actions associated with a request

The following Packet types may contain a request:

- Specific Request Packet
- General Request Packet
- FOD Status Packet
- Proprietary Packet
- Reserved Packet
- WPID Packet

If the Power Transmitter receives a Packet that is not listed above, it shall remove the Power Signal and return to the *selection* phase.

If the Power Transmitter does not receive a Packet correctly, it should ignore the Packet and remain in the *negotiation* phase without sending a Response or data Packet.

##### 5.1.2.4.2.1 *Specific Request Packet*

The Power Transmitter shall send an ND Response if

- the Request field contains a value listed as reserved in Table 43; or
- one or more of the reserved bits in the Request Value are set to ONE (see Section 5.2.3.13, *Specific Request Packet—FOD extensions only (0x20)*).

Otherwise, the Power Transmitter shall send a Response as defined in Table 13.

**Table 13. Power Transmitter responses in the *negotiation* phase**

Packet type	Power Transmitter response
Specific Request Packet	<p><b>Guaranteed Power.</b> If the Power Transmitter supports the requested Guaranteed Power Value, it shall update the Guaranteed Power in the temporary Power Transfer Contract and shall send an ACK Response. Otherwise, it shall send a NAK Response.</p>
	<p><b>Received Power Packet type.</b> If the Received Power Packet Header is 0x31 (24-bit Received Power Packet), the Power Transmitter shall update the Received Power Packet Format in the temporary Power Transfer Contract and shall send an ACK Response. Otherwise, the Power Transmitter shall send a NAK Response.</p>
	<p><b>FSK parameters.</b> The Power Transmitter shall update the requested FSK Polarity and Modulation Depth parameters in the temporary Power Transfer Contract and shall send an ACK Response.</p>
	<p><b>Maximum Power.</b> The Power Transmitter shall update the Maximum Power in the temporary Power Transfer Contract and shall send an ACK Response.</p>
	<p><b>Proprietary.</b> If the Power Transmitter does not have a defined Proprietary Response, it shall send a Not-Defined (ND) Response. Otherwise, it shall send its defined Proprietary Response, which may be an ACK Response, a NAK Response, or an ND Response.</p>
	<p><b>End Negotiation.</b> The Power Transmitter shall return to the <i>selection</i> phase if the Power Transmitter has not sent an ACK Response earlier in the <i>negotiation</i> phase to both</p> <ul style="list-style-type: none"> <li>▪ a Specific Request Packet with Request = 0x02 (Received Power Packet Type), and</li> <li>▪ an FOD Status Packet.</li> </ul> <p>Otherwise, the Power Transmitter shall verify that the Count Value matches the number of parameters that differ between the active Power Transfer Contract and the temporary Power Transfer Contract.</p> <ul style="list-style-type: none"> <li>▪ In the case of a match, the Power Transmitter shall send an ACK Response. Subsequently it shall copy the temporary Power Transfer Contract to the active Power Transfer Contract, and proceed to the <i>calibration</i> phase.</li> <li>▪ Otherwise, the Power Transmitter shall copy the active Power Transfer Contract to the temporary Power Transfer Contract, send a NAK Response, and remain in the <i>negotiation</i> phase.</li> </ul> <p>NOTE This action effectively discards all negotiated changes to the Power Transfer Contract.</p>

**Table 13. Power Transmitter responses in the *negotiation* phase (continued)**

Packet type	Power Transmitter response
General Request Packet	<p>The Power Transmitter shall send a Packet containing the information that is requested by the Power Receiver. If the Request is a reserved value, or a proprietary value for which the Power Transmitter does not have a defined Response (see Table 54 in Section 5.3.2.3.2, <i>Header</i>), the Power Transmitter shall send a Power Transmitter Data Not Available Packet (see Section 5.3.3.1, <i>Power Transmitter data not available Packet (0x00)</i>).</p> <p>NOTE Whereas General Request Packets enable a Power Receiver to obtain information from a Power Transmitter, they do not enable the Power Transmitter to modify the Power Transfer Contract.</p>
FOD Status Packet	<p>If the Mode field is set to a reserved value, or if the any one of the reserved bits is set to ONE, the Power Transmitter shall send an ND Response and ignore the content of the Packet. Otherwise, the Power Transmitter shall send</p> <ul style="list-style-type: none"> <li>▪ an ACK Response if it did not detect a Foreign Object; or</li> <li>▪ a NAK Response if it did detect a Foreign Object. In this case, the Power Transmitter shall return to the <i>selection</i> phase within 5 seconds irrespective of further communications from the Power Receiver.</li> </ul> <p>It is recommended that the Power Transmitter uses the Reference Quality Factor contained in the FOD Status Packet to determine its Response. For this purpose, the Power Transmitter should</p> <ul style="list-style-type: none"> <li>▪ adjust its quality-factor threshold based on the Reference Quality Factor Value;</li> <li>▪ compare its measured quality factor to its adjusted threshold; and</li> <li>▪ send an ACK or a NAK Response based on the comparison.</li> </ul> <p>See Section 11.3, <i>FOD based on quality factor change</i> for details.</p>
WPID Packet	<p>The Power Transmitter shall send</p> <ul style="list-style-type: none"> <li>▪ An ACK response if the WPID Packet was correctly received and the verification was successful.</li> <li>▪ A NAK response if the WPID Packet was correctly received but the verification failed.</li> <li>▪ An ND response if the Power Transmitter does not support WPID Packets.</li> </ul> <p>If the Power Transmitter supports the optional WPID Packets, it shall verify the Packet contents using the CRC algorithm described in Section 5.2.3.9.1.</p>
Proprietary Packet	<p>If the Power Transmitter does not have a defined proprietary Response, it shall send a Not-Defined (ND) Response. Otherwise, it shall send its defined proprietary Response, which may be an ACK Response, a NAK Response, an ND Response, or a proprietary data Packet.</p>
Reserved Packet	<p>The Power Transmitter shall send an ND Response.</p>

### 5.1.2.5 Calibration phase—FOD extensions only (PTx perspective)

In the calibration phase, the Power Transmitter should receive information from the Power Receiver that the Power Transmitter can use to improve the power loss method for Foreign Object Detection (see Section 11.4, *FOD based on calibrated power loss accounting*). In particular, the Power Transmitter should receive Received Power information, with the Power Receiver having attached

- a “light” load; and
- a “connected” load.

If the Power Transmitter does not receive this information, it should remove the Power Signal and return to the selection phase. In addition, the Power Transmitter should attempt to use this information to improve its power loss method only if it has ensured that there is no Foreign Object present.

In the *calibration* phase, the behavior of the Power Transmitter shall be the same as in the *power transfer* phase, with the following additions:

- If the Power Transmitter receives a 24-bit Received Power Packet with Mode = ‘001’ (calibration mode for a light load) and the Received Power Value satisfies the Power Transmitter, it shall send an ACK Response. Otherwise, it shall send a NAK Response.

NOTE Examples of reasons for sending a NAK Response include the following.

- The system is not sufficiently stable, which is the case if the Control Error Values received from the Power Receiver deviate substantially from zero.
  - The Received Power is greater than 15% of the Maximum Power of the Power Receiver (see Section 11.4, *FOD based on calibrated power loss accounting* for details).
  - The Power Transmitter measures a power loss that exceeds its threshold. It is up to the Power Transmitter designer to determine an appropriate threshold.
  - The Power Transmitter receives the Received Power Packet later than expected.
  - The Power Transmitter already has received a Received Power Packet with a Mode field containing a value other than ‘001’ (calibration for a light load).
- If the Power Transmitter receives a 24-bit Received Power Packet with Mode = ‘010’ (calibration mode for a connected load), and the Received Power Value satisfies the Power Transmitter, it shall send an ACK Response and proceed to the *power transfer* phase. Otherwise, it shall send a NAK Response.

NOTE Examples of reasons for sending a NAK Response include the following.

- The Power Transmitter measures a power loss that exceeds its threshold. It is up to the Power Transmitter designer to determine an appropriate threshold.
- The Power Transmitter receives the Received Power Packet later than expected.
- The Power Transmitter has not yet sent an ACK Response to a Received Power Packet with Mode = ‘001’ (calibration for a light load).

- The Power Transmitter considers the connected load not stable yet (e.g. based on the Control Error Values that it has received so far).

NOTE If the Power Transmitter does not receive a satisfactory Received Power Value within 10 seconds from entering the calibration phase, it should remove the Power Signal and return to the selection phase.

- If the Power Transmitter receives a 24-bit Received Power Packet with a Mode value other than '001' and '010', it should remove the Power Signal and return to the *selection* phase.

NOTE In this case, the Power Receiver has not correctly completed the calibration phase.

Figure 23 illustrates the above requirements.

**Figure 23. State diagram of the calibration phase**

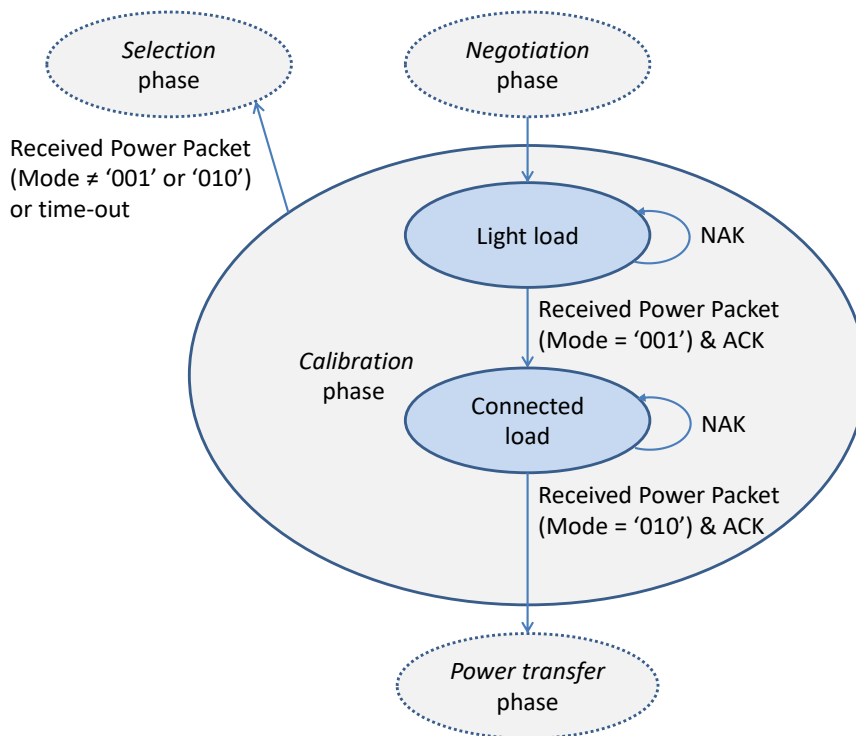

### 5.1.2.6 Power transfer phase (PTx perspective)

In the *power transfer* phase, the Power Transmitter controls the power transfer to the Power Receiver, in response to control data that it receives from the latter. For this purpose, the Power Transmitter shall receive zero or more of the following Packets:

- Control Error Packet.
- Received Power Packet.
- Charge Status Packet.
- End Power Transfer Packet.
- Renegotiate Packet.
- Any Proprietary Packet (as listed in Table 26). If the Power Transmitter does not know how to handle the message contained in the Proprietary Packet, the Power Transmitter shall ignore that message.
- Any reserved Packet (as indicated in Table 26). The Power Transmitter shall ignore the message contained in the reserved Packet.

The Power Transmitter shall receive the above Packets subject to the following timing constraints:

- If the Power Transmitter does not correctly receive the start of the first Control Error Packet within the time window  $t_{\text{timeout}}$  after the start of the Configuration Packet, which the Power Transmitter has received in the *identification & configuration* phase, the Power Transmitter shall remove the Power Signal within  $t_{\text{terminate}}$ . If the Power Transmitter does not correctly receive the start of a Control Error Packet within the time window  $t_{\text{timeout}}$  after the start of the preceding Control Error Packet, the Power Transmitter shall remove the Power Signal within  $t_{\text{terminate}}$ . See Figure 24(a).
- If the Power Transmitter does not correctly receive the start of the first Received Power Packet within the time window  $t_{\text{power}}$  after the start of the Configuration Packet, which the Power Transmitter has received in the *identification & configuration* phase, the Power Transmitter shall remove the Power Signal within  $t_{\text{terminate}}$ . If the Power Transmitter does not correctly receive the start of a Received Power Packet within the time window  $t_{\text{power}}$  after the start of the preceding Received Power Packet, the Power Transmitter shall remove the Power Signal within  $t_{\text{terminate}}$ . See Figure 24(e).

**Figure 24. Power Transmitter timing in the *power transfer phase***

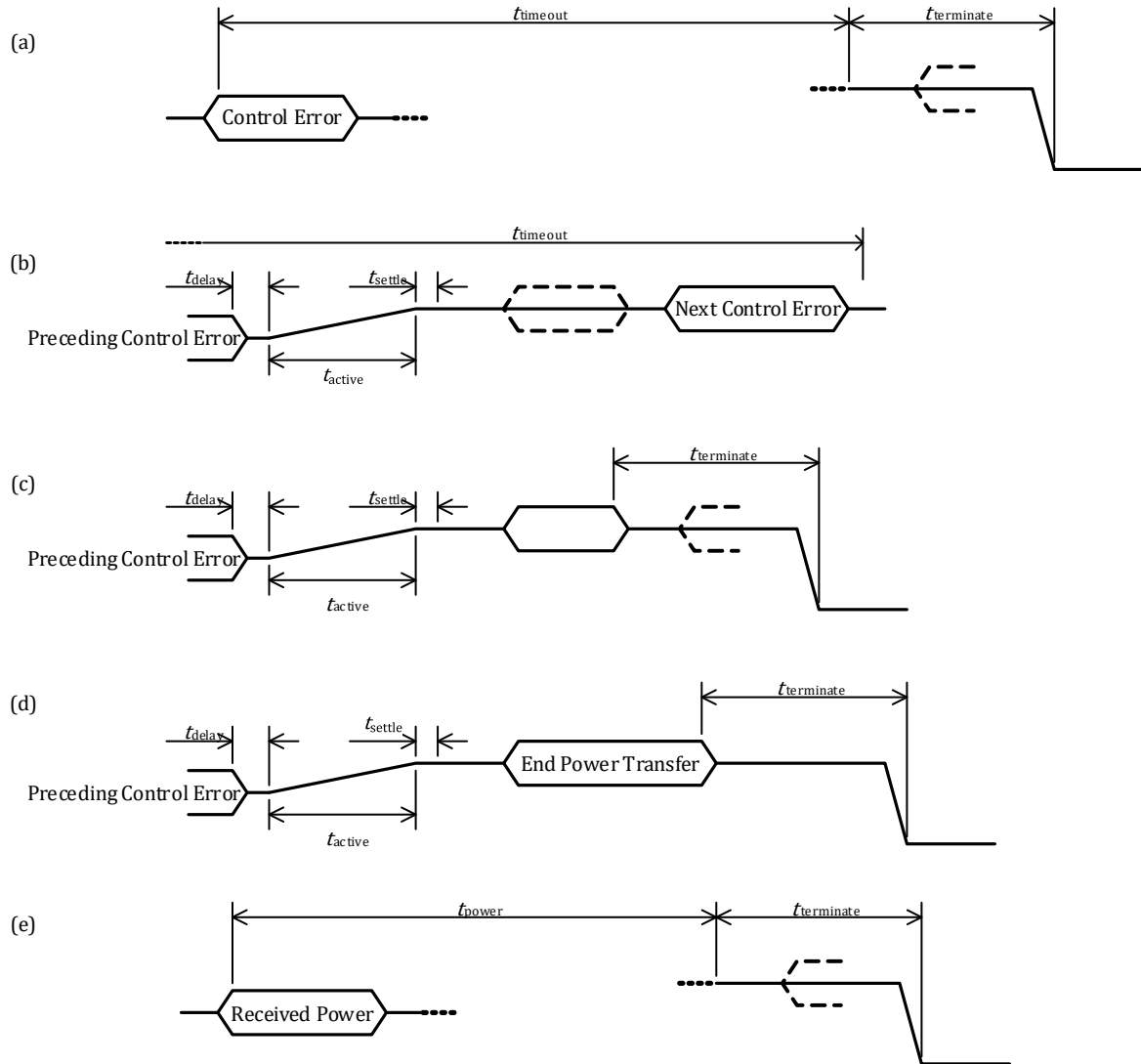



**Table 14. Power Transmitter timing in the *power transfer* phase**

Parameter	Symbol	Minimum	Target	Maximum	Unit
Control Error Packet time out	$t_{\text{timeout}}$	700.0 <sub>-0</sub>	1500	1800.0 <sup>+0</sup>	ms
Power control active time	$t_{\text{active}}$	N.A.	20	21.0 <sup>+0</sup>	ms
Power control settling time	$t_{\text{settle}}$	3.0 <sub>-0</sub>	5	7.0 <sup>+0</sup>	ms
Received Power Packet time*	$t_{\text{power}}$	8000.0 <sub>-0</sub>	23000	24000 <sup>+0</sup>	ms

\* NOTE A Power Transmitter should apply this time-out value also if connected to a Power Receiver that complies with revision 1.0.x of the System Description Wireless Power Transfer.

In addition to the above timing constraints, the Power Transmitter shall execute the following actions.

- Upon receiving a Control Error Value, the Power Transmitter shall adjust its Operating Point, as defined in Section 5.1.2.6.1, during a time window  $t_{\text{active}}$ . Prior to making any adjustment, the Power Transmitter shall wait for an interval  $t_{\text{delay}}$  to enable the Primary Cell current to stabilize again after communications. See Figure 24(b).
- If the Power Transmitter correctly receives a Packet that does not comply with the above sequence, the Power Transmitter shall remove the Power Signal within  $t_{\text{terminate}}$  after the end of that Packet. See Figure 24(c).
- If the Power Transmitter receives an End Power Transfer Packet, the Power Transmitter shall remove the Power Signal within  $t_{\text{terminate}}$  after the end of the End Power Transfer Packet. See Figure 24(d).
- The Power Transmitter shall monitor the parameters contained in the Power Transfer Contract throughout the power transfer phase. If the Power Transmitter detects that the actual value of any of those parameters exceeds the limits contained in the Power Transfer Contract, the Power Transmitter shall remove the Power Signal within  $t_{\text{terminate}}$ .
- If the Power Transmitter has removed the Power Signal, the Power Transmitter shall revert to the *selection* phase.

**FOD extensions supported:** In this case the Power Transmitter shall also execute the following actions.

- If the Power Transmitter receives a Renegotiate Packet, it shall send an ACK Response, and subsequently proceed to the *renegotiation* phase.
- If the Power Transmitter receives a Received Power Packet with a format that is different from the format that is agreed in the Power Transfer Contract, it shall remove the Power Signal and return to the *selection* phase.

- If the Power Transmitter receives a 24-bit Received Power Packet with Mode = '000', the Power Transmitter shall send the Response within  $t_{\text{response}}$  after the end of the Received Power Packet. See Figure 25 and Figure 22 in Section 5.1.2.4.1, *Timing constraints*. The Power Transmitter shall send an ACK Response to indicate that the power transfer can proceed as-is. It shall send a NAK Response to indicate that the Power Receiver should reduce its power consumption.

A Power Transmitter typically sends a NAK Response in one or more of the following cases.

- It has determined that a Foreign Object has entered the magnetic field.
- It cannot support the current power level because of an increased ambient temperature.
- It is operating close to (or beyond) its limits due to, for example, a low coupling condition.

**NOTE** If the Power Transmitter has sent a NAK Response, it should continue transferring power in order to give the Power Receiver the opportunity to reduce its power consumption. After issuing several NAK Responses in a row without detecting a sufficient decrease in the power level, the Power Transmitter should terminate the power transfer.

**Figure 25. Timing of the Response to a Received Power Packet**

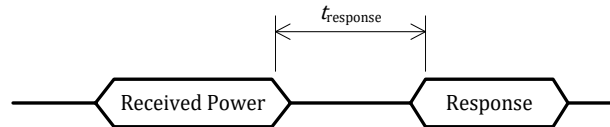

- If the Power Transmitter receives a Received Power Packet with Mode = '001' or Mode = '010', it shall ignore the Received Power Value and shall send an ND Response.
- If the Power Transmitter receives an End Power Transfer Packet that contains an End Power transfer Code of 0x0B (Restart Power Transfer), it shall
  - remove the Power Signal;
  - attempt to detect the presence of a Foreign object (e.g. using the quality factor method defined in Section 11.3); and
  - within  $t_{\text{restart}} = 500$  ms proceed to the *ping* phase.

#### 5.1.2.6.1 Power transfer control

This version of the Specification, defines a specific method, which the Power Transmitter shall use to control its Primary Cell current towards the new Primary Cell current (see Section 5.1.1, *Overview (informative)*). This method is based on a discrete proportional-integral-differential (PID) algorithm as illustrated in Figure 26.

**Figure 26. PID control algorithm**

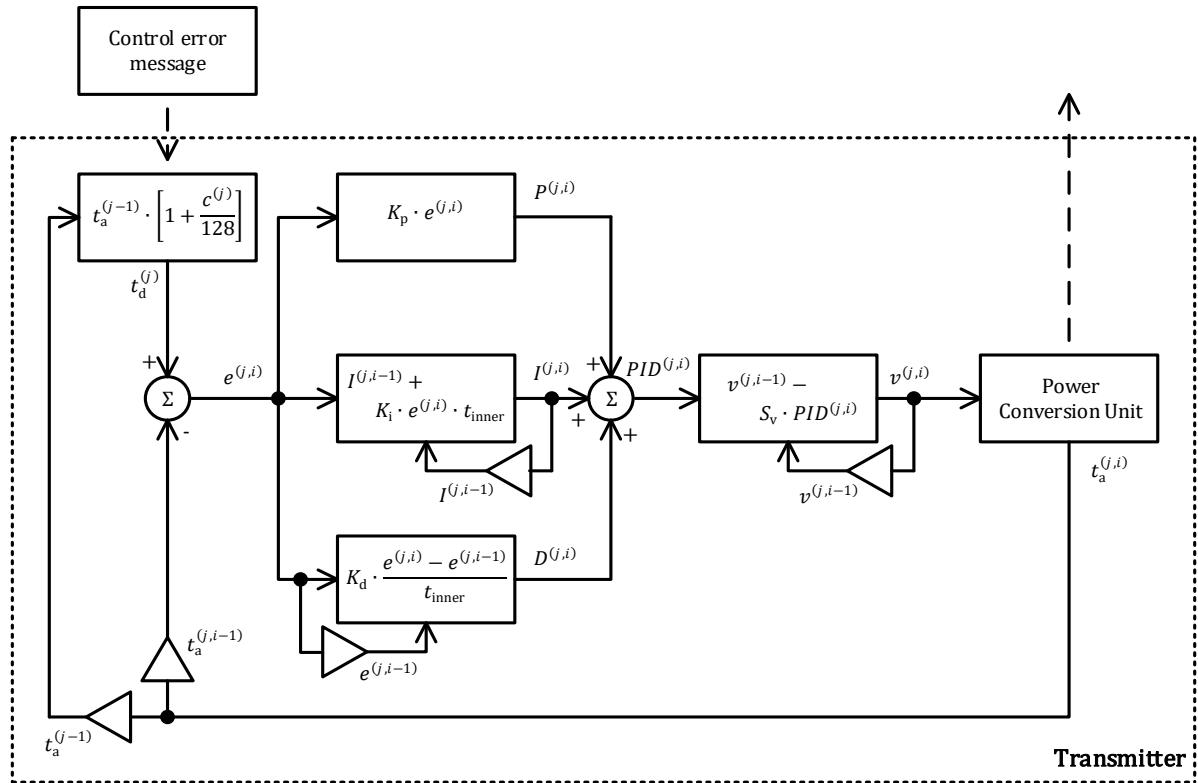

To execute this algorithm, the Power Transmitter shall execute the steps listed below, in the order of appearance. In the definitions of these steps, the index  $j = 1, 2, 3, \dots$  labels the sequence of Control Error Packets, which the Power Transmitter receives.

- Upon receipt of the  $j^{\text{th}}$  Control Error Packet, the Power Transmitter shall calculate the new Primary Cell current  $t_d^{(j)}$  as

$$t_d^{(j)} = t_a^{(j-1)} \cdot \left[ 1 + \frac{c^{(j)}}{128} \right],$$

where  $t_a^{(j-1)}$  represents the actual Primary Cell current—reached in response to the previous Control Error Packet—and  $c^{(j)}$  represents the Control Error Value contained in the  $j^{\text{th}}$  Control Error Packet. Note that  $t_a^{(0)}$  represents the Primary Cell current at the start of the *power transfer* phase.

- If the Control Error Value  $c^{(j)}$  is non-zero, the Power Transmitter shall adjust its Primary Cell current during a time window  $t_{\text{active}}$ . For this purpose, the Power Transmitter shall execute a loop comprising of the steps listed below. The index  $i = 1, 2, 3, \dots, i_{\text{max}}$  labels the iterations of this loop.
  - The Power Transmitter shall calculate the difference between the new Primary Cell and the actual Primary Cell current as the error

$$e^{(j,i)} = t_d^{(j)} - t_a^{(j,i-1)},$$

where  $t_a^{(j,i-1)}$  represents the Primary Cell current determined in iteration  $i - 1$  of the loop. Note that  $t_a^{(j,0)}$  represents the actual Primary Cell current at the start of the loop.

- The Transmitter shall calculate the proportional, integral, and derivative terms (in any order):

$$P^{(j,i)} = K_p \cdot e^{(j,i)},$$

$$I^{(j,i)} = I^{(j,i-1)} + K_i \cdot e^{(j,i)} \cdot t_{\text{inner}},$$

$$D^{(j,i)} = K_d \cdot \frac{e^{(j,i)} - e^{(j,i-1)}}{t_{\text{inner}}},$$

where  $K_p$  is the proportional gain,  $K_i$  is the integral gain,  $K_d$  is the derivative gain, and  $t_{\text{inner}}$  is the time required to execute a single iteration of the loop. In addition, the integral term  $I^{(j,0)} = 0$ , and the error  $e^{(j,0)} = 0$ . The Power Transmitter shall limit the integral term  $I^{(j,i)}$  such that it remains within the range  $-M_i \dots + M_i$ —if necessary, the Power Transmitter shall replace the calculated integral term  $I^{(j,i)}$  with the appropriate boundary value.

- The Power Transmitter shall calculate the sum of the proportional, integral, and derivative terms:

$$PID^{(j,i)} = P^{(j,i)} + I^{(j,i)} + D^{(j,i)}.$$

In this calculation, the Power Transmitter shall limit the sum  $PID^{(j,i)}$  such that it remains within the range  $-M_{PID} \dots + M_{PID}$ .

- The Power Transmitter shall calculate the new value of the controlled variable

$$v^{(j,i)} = v^{(j,i-1)} - S_v \cdot PID^{(j,i)},$$

where  $S_v$  is a scaling factor that depends on the controlled variable. In addition, the controlled variable  $v^{(j,0)} = v^{(j-1,i_{\text{max}})}$ , with  $v^{(0,0)}$  representing the actual value of the controlled variable at the start of the *power transfer* phase, is either the Operating Frequency, the duty cycle of the inverter, or the voltage input to the inverter. If the calculated  $v^{(j,i)}$  exceeds the specified range (see the definition of the individual Power Transmitter designs in *Part 4: Reference Designs*), the Power Transmitter shall replace the calculated  $v^{(j,i)}$  with the appropriate limiting value.

- The Power Transmitter shall apply the new value of the controlled variable  $v^{(j,i)}$  to its Power Conversion Unit.

- The Power Transmitter shall determine the actual Primary Cell current  $t_a^{(j,i)}$ .

The maximum number of iterations of the loop  $i_{\max}$ , and the time  $t_{\text{inner}}$  required to execute a single iteration of the loop shall satisfy the following relation:

$$i_{\max} \cdot t_{\text{inner}} = t_{\text{active}}, \text{ with } 1 \text{ ms} \leq t_{\text{inner}} \leq 5 \text{ ms.}$$

- The Power Transmitter shall determine the Primary Cell current  $t_a^{(j)}$  exactly at  $t_{\text{delay}} + t_{\text{active}} + t_{\text{settle}}$  after the end of the  $j^{\text{th}}$  Control Error Packet.

See the definition of the individual Power Transmitter designs in Section 5.1.3.4.2.1, *Specific request*, for the values of  $K_p$ ,  $K_i$ ,  $K_d$ ,  $M_I$ ,  $M_{\text{PID}}$  and  $S_v$ .

### 5.1.2.7 Renegotiation phase—FOD extensions only (PTx perspective)

The behavior of the Power Transmitter in the *renegotiation* phase shall be the same as in the *negotiation* phase with the following exceptions.

- If the Power Transmitter receives a Control Error Packet, Received Power Packet, or Charge Status Packet, it shall discard the temporary Power Transfer Contract and return to the *power transfer* phase.
- If the Power Transmitter receives an FOD Status Packet, it shall send an ND Response.
- If the Power Transmitter has received a Specific Request Packet with Request = 0x00 (End Negotiation), it shall base its Response on a verification of the Count Value only (see Section 5.1.3.4.2.1, *Specific request*).

### 5.1.3 Power Receiver (PRx) perspective

This section defines the protocol that a Power Receiver shall execute to receive power from a Power Transmitter. Each of the seven phases is defined in a separate subsection of this section:

- *Selection* phase. Section 5.1.3.1 defines the initial Response of the Power Receiver to the application of a Power Signal. As part of this initial Response, the Power Receiver wakes up its Communications and Control Unit—if that is not already up and running.
- *Ping* phase. Section 5.1.3.2 defines the Response of a Power Receiver to a Digital Ping. This Response ensures the Power Transmitter that it is dealing with a Power Receiver rather than some unknown object.
- *Identification & configuration* phase. Section 5.1.3.3 defines the Response of a Power Receiver to an extended Digital Ping. In this phase, the Power Receiver identifies itself and provides information for a default Power Transfer Contract.
- *Negotiation* phase (FOD extensions only). Section 5.1.3.4 defines the part of the protocol in which the Power Receiver negotiates changes to the default Power Transfer Contract. In addition, the Power Receiver verifies that the Power Transmitter has not detected a Foreign Object (so far).
- *Calibration* phase (FOD extensions only). Section 5.1.3.5 defines the part of the Protocol that the Power Receiver shall execute during the *calibration* phase. In this phase, the Power Receiver provides information that the Power Transmitter can use to improve its ability to detect Foreign Objects during power transfer.
- *Power transfer* phase. Section 5.1.3.6 defines the part of the protocol that the Power Receiver shall execute during power transfer.
- *Renegotiation* phase (FOD extensions only). Section 5.1.3.7 defines the part of the protocol that the Power Receiver can execute to request modification of the Power Contract.

Many provisions in this section refer to the start and/or the end of a Packet, or the start of a Packet's preamble. In the case that a Packet is sent from the Power Receiver to the Power Transmitter,

- the start of a Packet is defined as the instant that the Power Receiver transmits the first edge of the start bit of the Packet's header byte;
- the end of a Packet is defined as the instant that the Power Receiver transmits the second edge of the stop bit of the Packet's checksum byte; and
- the start of a Packet's preamble is defined as the instant that the Power Receiver transmits the first edge of the first preamble bit.

In the case of a Packet or Response sent from the Power Transmitter to the Power Receiver,

- the start of the Packet or Response is defined as the instant of the first zero crossing of the first Power Signal cycle in which the Operating Frequency changes in accordance with the FSK modulation requirements; and
- the end of the Packet or Response is defined as the instant of the first zero crossing of the first Power Signal cycle in which the Operating Frequency changes back to the original Operating Frequency in accordance with the FSK modulation requirements following the final transition of the Packet or Response.

In addition to the timing constraints given in the next subsections, the Power Receiver shall return to the *selection* phase within the time window  $t_{\text{reset}}$  (see Table 15) after the Power Transmitter removes the Power Signal. Here, the time window  $t_{\text{reset}}$  starts from the instant that the current amplitude of the Primary Cell crosses 50% of the stable level.

NOTE This Specification does not define how the Power Receiver should detect that the Power Transmitter removes the Power Signal.

**Table 15. Power Receiver reset timing**

Parameter	Symbol	Minimum	Target	Maximum	Unit
Power Receiver reset time	$t_{\text{reset}}$	N.A.	25	28.0 <sup>+0</sup>	ms

Moreover, and notwithstanding the timing constraints provided in this section (5.1.3), the Power Receiver may stop transmitting Packets to the Power Transmitter at any time.

NOTE This behavior should cause the Power Transmitter to remove the Power Signal under the assumption that a user has removed the Power Receiver from the Interface Surface. The recommended behavior for directing the Power Transmitter to remove the Power Signal (if a user has not removed the Power Receiver from the Interface Surface) is to transmit an End Power Transfer Packet.

### 5.1.3.1 Selection phase (PRx perspective)

As soon as the Power Transmitter applies a Power Signal, the Power Receiver shall enter the *selection* phase if the Power Receiver is not in the *selection* phase already.<sup>6</sup>

NOTE This Specification does not define how the Power Receiver should detect that the Power Transmitter applies a Power Signal.

If the Power Receiver considers the rectified voltage  $V_r$  to be sufficiently high, the Power Receiver shall proceed to the *ping* phase, such that the first Packet (see Section 5.1.3.2, *Ping phase (PRx perspective)*) starts at  $t_{wake}$ . Here, the time  $t_{wake}$  starts from the instant that the Primary Cell current amplitude crosses 50% of the stable level. See Figure 27 and Table 16.

If the Power Receiver does not proceed to the *ping* phase, the Power Receiver shall not transmit any Packet.

**Figure 27. Power Receiver timing in the *selection* phase**

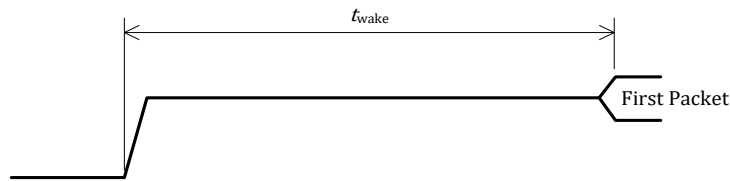

**Table 16. Power Receiver timing in the *selection* phase**

Parameter	Symbol	Minimum	Target	Maximum	Unit
Wake up time	$t_{wake}$	19.0 <sub>-0</sub>	40	64.0 <sup>+0</sup>	ms

<sup>6</sup> NOTE If the Power Receiver needs time to start up its Communications and Control Unit, the Power Receiver shall consider itself to be in the *selection* phase during that start-up time. In general, the Power Receiver may consider itself to be in the *selection* phase whenever it is not in any of the other phases: the *ping* phase, the *identification & configuration* phase, the *negotiation* phase, the *calibration* phase, the *power transfer* phase, or the *renegotiation* phase.



### 5.1.3.2 Ping phase (PRx perspective)

If the Power Receiver responds to the Digital Ping, the Power Receiver shall transmit either a Signal Strength Packet or an End Power Transfer Packet as its first Packet. The Power Receiver shall transmit this first Packet immediately upon entering the *ping* phase.

**Figure 28. Power Receiver timing in the ping phase**

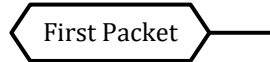

After the Power Receiver has transmitted a Signal Strength Packet, the Power Receiver shall proceed to the *identification & configuration* phase. After the Power Receiver has transmitted an End Power Transfer Packet, it shall remain in the *ping* phase. In that case, the Power Receiver should transmit additional End Power Transfer Packets.<sup>7</sup>

### 5.1.3.3 Identification & configuration phase (PRx perspective)

In the *identification & configuration* phase, the Power Receiver shall transmit the following sequence of Packets:

- If the Power Receiver enters the *identification & configuration* phase from the *ping* phase, an Identification Packet.
- If the Ext bit of the preceding Identification Packet is set to ONE, an Extended Identification Packet.
- Up to 7 optional configuration Packets from the following set (the order in which the Power Receiver transmits these Packets, if any, is not relevant):
  - A Power Control Hold-off Packet. The Power Control Hold-off Time  $t_{\text{delay}}$  contained in this Packet shall satisfy the relation  $t_{\text{delay}}^{(\text{min})} \leq t_{\text{delay}} \leq t_{\text{delay}}^{(\text{max})}$ . See Table 10.
  - Any Proprietary Packet (as listed in Table 26).
- A Configuration Packet.

Until further notice, Proprietary Packets shall not be contained in the sequence of Packets. The reason is that some early Base Station implementations cannot handle such Packets. This restriction may be removed in the future.

<sup>7</sup> The Power Transmitter can miss the first End Power Transfer Packet, e.g. due to a communications error, and continue to apply the Power Signal.

The Power Receiver shall transmit the above sequence of Packets subject to the following timing constraints:

- The Power Receiver shall not start the preamble of the next Packet in the sequence within the time interval  $t_{\text{silent}}$  after the end of the directly preceding Packet in the sequence.
- The next Packet in the sequence shall start at  $t_{\text{start}}$  after the end of a preceding Packet.

NOTE See the definition of the start of a Packet in Section 5.1.3.

With respect to the above timing constraints, if the Power Receiver has entered the *identification & configuration* phase from the *ping* phase, the Packet directly preceding the Identification Packet is the Signal Strength Packet, which the Power Receiver has transmitted in the *ping* phase. See Figure 29 and Table 17.

**FOD extensions not supported:** The Power Receiver shall set the Neg bit in its Configuration packet to ZERO. It should also set the Polarity bit to ZERO and Depth field to 0x0. After the Power Receiver has transmitted a Configuration Packet, the Power Receiver shall proceed to the *power transfer* phase.

**Figure 29. Power Receiver timing in the *identification & configuration* phase**

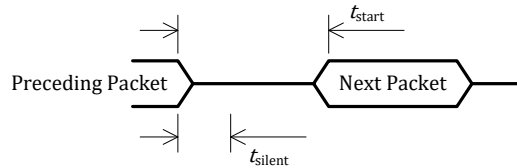

**Table 17. Power Receiver timing in the *identification & configuration* phase**

Parameter	Symbol	Minimum	Target	Maximum	Unit
Silent time*	$t_{\text{silent}}$	6.0 <sub>-0</sub>	7	—	ms
Start time	$t_{\text{start}}$	11.5 <sub>-0</sub>	N.A.	19.0 <sup>+0</sup>	ms

\* The maximum number of preamble bits depends on the difference between the value of  $t_{\text{start}}$  and the minimum value of  $t_{\text{silent}}$ .

**FOD extensions supported:** The Power Receiver shall not send Proprietary Packets during the *identification & configuration* phase. Moreover, if the Maximum Power of the Power Receiver exceeds 5 W, it shall set the Neg field in its Configuration Packet to ONE and monitor for a Response from the Power Transmitter. If the Maximum Power of the Power Receiver does not exceed 5 W, it may set the Neg field in its Configuration Packet to ONE and monitor for a Response from the Power Transmitter. If the Power Receiver does not receive the first bit of an ACK Response within  $t_{\text{responsetimeout}}$  after the end of the Configuration Packet, it shall:

- assume that the Power Transmitter is not able to negotiate;
- assume that the Power Transmitter supports a Guaranteed Power of 5 W only; and
- proceed to the power transfer phase.

Otherwise, the Power Receiver shall proceed to the *negotiation* phase. See Figure 30 and Figure 24.

**Figure 30. Power Receiver timing in the identification & configuration phase (FOD Extensions)**

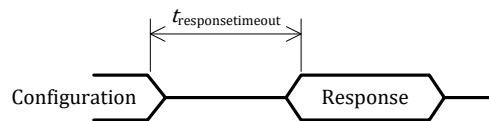

**Table 18. Power Receiver timing in the *identification & configuration* phase (FOD extensions)**

Parameter	Symbol	Minimum	Target	Maximum	Unit
Response time out	$t_{\text{responsetimeout}}$	15.0 <sub>-0</sub>	(30.0 <sup>+0</sup> )	(50.0 <sup>+0</sup> )	ms

At the end of the *identification & configuration* phase, the Power Receiver should create a Power Transfer Contract containing the parameters shown in Table 19.

**Table 19. Initial Power Transfer Contract**

Parameter	Value
Guaranteed Power	5 W
Maximum Power	Derived from the Maximum Power Value contained in the Configuration Packet
Received Power Packet Format	8-bit Received Power Value (header 0x04)
FSK Polarity / Modulation Depth	Value contained in the Configuration Packet

### 5.1.3.4 Negotiation phase—FOD extensions only (PRx perspective)

In the *negotiation* phase, the Power Receiver shall send a series of Packets that contain requests to update the Power Transfer Contract. In response to each Packet, the Power Receiver should receive either

- a Response, which indicates whether the Power Transmitter grants the request, denies the request, or does not recognize the request; or
- a data Packet, which contains the requested information.

Prior to transmitting the requests to update the Power Transfer Contract, the Power Receiver shall create a temporary copy of the Power Transfer Contract. The Power Receiver shall use this temporary copy to store updated parameters until successful completion of the *negotiation* phase.

#### 5.1.3.4.1 Timing constraints

In the *negotiation* phase, the Power Receiver shall transmit its Packets subject to the following timing constraints (see Figure 31 and Table 20):

- The Power Receiver shall not start to transmit the preamble of the next Packet within the time interval  $t_{\text{silent}}$  after receiving the end of a Response or Packet from the Power Transmitter.
- The Power Receiver shall transmit the first start bit of the next Packet within the time interval  $t_{\text{start}}$  after receiving the end of a Response or Packet from the Power Transmitter.

**Figure 31. Power Receiver timing in the *negotiation* phase (transmit)**

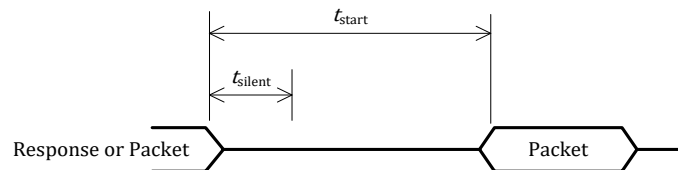
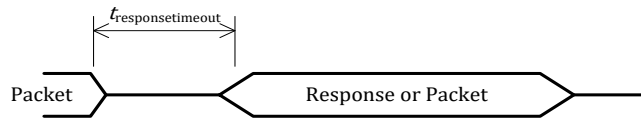

**Table 20. Power Receiver timing in the *negotiation* phase (transmit)**

Parameter	Symbol	Minimum	Target	Maximum	Unit
Silent time	$t_{\text{silent}}$	6.0 <sub>-0</sub>	7	N.A.	ms
Start time	$t_{\text{start}}$	11.5 <sub>-0</sub>	N.A.	19.0 <sup>+0</sup>	ms

If the Power Receiver does not detect the start of a Response or Packet from the Power Transmitter within  $t_{\text{responsetimeout}}$  after the end of its transmitted Packet, it should assume that its transmitted Packet has not been received by the Power Transmitter. It is recommended that in this case the Power Receiver resends its transmitted Packet as quickly as possible. If, after three retries, the Power Receiver still does not receive a Response or Packet, the Power Receiver should assume that the Power Transmitter does not support its request.

**Figure 32. Power Receiver timing in the *negotiation* phase (receive)**



**Table 21. Power Receiver timing in the *negotiation* phase (receive)**

Parameter	Symbol	Minimum	Target	Maximum	Unit
Silent time	$t_{\text{responsetimeout}}$	15.0 <sub>-0</sub>	(30.0 <sup>+0</sup> )	(50.0 <sup>+0</sup> )	ms

#### 5.1.3.4.2 Actions associated with a request

In the *negotiation* phase, the Power Receiver shall send a sequence of Packets that may contain the following Packet types:

- Specific Request Packet
- General Request Packet
- FOD Status Packet
- Proprietary Packet
- WPID Packet

NOTE In order to direct the Power Transmitter to remove the Power Signal, the Power Receiver may also send an End Power Transfer Packet with any End Power Transfer Code, or any other Packet that is not contained in the above list.

##### 5.1.3.4.2.1 Specific request

The Power Receiver can use a Specific Request Packet in order to negotiate changes to the Power Transfer Contract.

If the Power Receiver receives an ND Response to this Packet, it shall assume that its request is not supported by the Power Transmitter.

**Table 22. Power Receiver responses to Specific Request Packets**

Packet type	Power Transmitter response
Guaranteed Power	<p>The Power Receiver can use this request to change the Guaranteed Power in the Power Transfer Contract.</p> <p>If the Power Receiver receives an ACK Response, it shall update the Guaranteed Power in its temporary Power Transfer Contract.</p>
Received Power Packet type	<p>The Power Receiver can use this request to change the Received Power Packet Format in the Power Transfer Contract.</p> <p>The Power Receiver shall set the Received Power Packet Header field of this request to 0x31 (24-bit Received Power Packet).</p> <p>The Power Receiver shall transmit this request at least once during the <i>negotiation</i> phase.</p> <p>If the Power Receiver receives an ACK Response, it shall update the Received Power Packet Format in its temporary Power Transfer Contract.</p>
FSK parameters	<p>The Power Receiver can use this request to change the FSK Polarity and Modulation Depth parameters in the Power Transfer Contract.</p> <p>If the Power Receiver receives an ACK Response, it shall update the FSK Polarity and Modulation Depth parameters in its temporary Power Transfer Contract.</p>
Maximum Power	<p>The Power Receiver can use this request to change the Maximum Power in the Power Transfer Contract.</p> <p>If the Power Receiver receives an ACK Response, it shall update the Maximum Power in its temporary Power Transfer Contract.</p>
Proprietary	<p>The Power Receiver can use one of the proprietary requests to change a proprietary parameter in the Power Transfer Contract.</p>
End negotiation	<p>The Power Receiver shall use this request to finalize the <i>negotiation</i> phase. The Power Receiver shall set the Count Value in this request to match the number of parameters that differ between the active Power Transfer Contract and the temporary Power Transfer Contract.</p> <p>If the Power Receiver receives an ACK Response, it shall copy the temporary Power Transfer Contract to the active Power Transfer Contract. Subsequently, it shall proceed to the <i>calibration</i> phase.</p> <p>If the Power Receiver receives a NAK Response, it shall copy the active Power Transfer Contract to the temporary Power Transfer Contract to discard all negotiated changes. Subsequently, it may</p> <ul style="list-style-type: none"> <li>▪ remain in the <i>negotiation</i> phase and attempt to again negotiate its desired changes to the Power Transfer Contract; or</li> <li>▪ send an End Power Transfer Packet with End power Transfer Code = 0x0A (Negotiation Failure) that should direct the Power Transmitter to remove the Power Signal.</li> </ul>

#### 5.1.3.4.2.2 *General request*

The Power Receiver can use this request to obtain information from the Power Transmitter. See Section 5.2.3.12, *General Request Packet—FOD extensions only (0x07)*, and Section 5.2.3, *Logical layer*, for details.

#### 5.1.3.4.2.3 *FOD Status Packet*

The Power Receiver can use this request check if the Power Transmitter has detected a Foreign Object prior to receiving this FOD Status Packet.

The Power Receiver shall set the Reference Quality Factor field of this request to an appropriate value. See Section 11.3, *FOD based on quality factor change*, for details.

The Power Receiver shall transmit this request at least once during the *negotiation* phase.

If the Power Receiver receives a NAK Response or an ND Response, it should not attempt to provide more than 5 W of power at its output until the Power Transmitter removes the Power Signal (which should happen within 5 seconds).

#### 5.1.3.4.2.4 *WPID Packets*

The Power Receiver can optionally use a WPID Packet to identify itself to the Power Transmitter by sending a unique identification number.

The Power Receiver should interpret responses to WPID Packets as follows:

- If the Power Receiver receives an ACK Response, it should assume the Power Transmitter successfully received the Packet and verified the CRC data.
- If the Power Receiver receives an ND Response, it should assume that the Power Transmitter does not support WPID.
- If the Power Receiver receives a NAK Response, it should assume that a communication error occurred and it should resend the WPID Packet. The WPID value is transferred in two Packets; only the Packet(s) that received a NAK should be resent.

#### 5.1.3.4.2.5 *Proprietary Packet*

The Power Receiver can use Proprietary Packets for proprietary negotiation purposes. Before transmitting such Packets, the Power Receiver should verify that the Power Transmitter can handle those Packets. Hereto, the Power Receiver should transmit a General Request Packet with Request = 0x30 (Power Transmitter Identification Packet).

### 5.1.3.5 Calibration phase—FOD extensions only (PRx perspective)

NOTE In the calibration phase, the Power Receiver sends information to the Power Transmitter, which the latter can use to improve its power loss method for Foreign Object Detection (see Section 11.4, *FOD based on calibrated power loss accounting*). In particular, the Power Receiver transmits Received Power information, with the Power Receiver having attached a “light” load and a “connected” load.

In the *calibration* phase, the behavior of the Power Receiver shall be the same as in the *power transfer* phase, with the following additions.

- The Power Receiver shall initially have a “light” load attached and use 24-bit Received Power Packets with Mode = ‘001’ (calibration mode for a light load). See Section 11.4, *FOD based on calibrated power loss accounting*, for details. The Power Receiver shall use a time interval  $t_{\text{received}}$  of at most 0.5 seconds for these Packets. The Power Receiver shall transmit the first Received Power Packet within 0.5 seconds from the start of the Specific request with Request = 0x00 (End Negotiation). The Power Receiver shall continue to use 24-bit Received Power Packets with Mode = ‘001’ (calibration mode for light load) until it receives an ACK Response from the Power Transmitter.
- Subsequently, the Power Receiver shall connect its load (i.e. close its output disconnect switch, see Section 3.1.7, *Meaningful functionality*), and shall start to use 24-bit Received Power Packets with Mode = ‘010’ (calibration mode for a connected load). The Power Receiver shall use a time interval  $t_{\text{received}}$  of at most 2.0 seconds for these Packets. The Power Receiver shall continue to use the 24-bit Received Power Packets with Mode = ‘010’ (calibration mode for a connected load) until it receives an ACK Response from the Power Transmitter.
- Subsequently, the Power Receiver shall proceed to the *power transfer* phase.

### 5.1.3.6 Power transfer phase (PRx perspective)

In the *power transfer* phase, the Power Receiver controls the power transfer from the Power Transmitter, by means of control data that it transmits to the latter. For this purpose, the Power Receiver shall transmit zero or more of the following Packets:

- Control Error Packet. The Power Receiver shall set the Control Error Value to zero if the actual Control Point is equal to the desired Control Point. The Power Receiver shall set the Control Error Value to a negative value to request a decrease of the Primary Cell current. The Power Receiver shall set the Control Error Value to a positive value to request an increase of the Primary Cell current. See Sections 5.1.1, *Overview (informative)*, and 5.1.2.6.1, *Power transfer control*.
- Received Power Packet.
- Charge Status Packet.
- End Power Transfer Packet.
- Any Proprietary Packet (as listed in Table 26).



The Power Receiver shall transmit the above Packets subject to the following timing constraints:

- The Power Receiver shall not start to transmit the preamble of any Packet within the time window  $t_{\text{silent}}$  after the end of the Packet directly preceding it. As an additional constraint, the preamble of any Packet shall not start within the time window  $t_{\text{delay}} + t_{\text{control}}$  after the end of a Control Error Packet, where  $t_{\text{delay}}$  is the Power Control Hold-off value, which the Power Receiver has transmitted using the last Power Control Hold-off Packet in the *identification & configuration* phase. If the Power Receiver has not transmitted a Power Control Hold-off Packet to the Power Transmitter, the Power Receiver shall use  $t_{\text{delay}} = t_{\text{delay}}^{(\text{min})}$  (see Table 10).
- The first Control Error Packet shall start within the time window  $t_{\text{interval}}$  after the start of the Configuration Packet. A next Control Error Packet shall start within the time window  $t_{\text{interval}}$  after the start of the preceding Control Error Packet. As an additional constraint, the average of the time  $t_{\text{interval}}$  between consecutive Control Error Packets shall be at most 260 ms.
- It is recommended that the Power Receiver determines its actual Control Point at  $t_{\text{delay}} + t_{\text{control}}$  after the end of a Control Error Packet.
- The first Received Power Packet shall start within the time window  $t_{\text{received}}$  after the start of the Configuration Packet. A next Received Power Packet shall start within the time window  $t_{\text{received}}$  after the start of the preceding Received Power Packet.
- The Power Receiver shall determine the average power received through its Interface Surface in a time window of length  $t_{\text{window}}$ , which precedes the start of the corresponding Received Power Packet by a time  $t_{\text{offset}}$ . It is recommended to use at least four samples for the averaging. The window length and offset shall be chosen such that the time window does not overlap with the preamble of the Received Power Packet or a preceding Packet. See Section 11, *Foreign Object Detection*.

See Figure 33 and Table 23.

Moreover, if the Power Receiver has transmitted an End Power Transfer Packet, the Power Receiver shall remain in the *power transfer* phase until the Power Transmitter removes the Power Signal. Furthermore, the Power Receiver should transmit additional End Power Transfer Packets if the Power Transmitter does not remove the Power Signal.<sup>8</sup> For battery-charging applications, it is recommended that the Power Receiver sends an End Power Transfer Packet containing an End Power Transfer Code 0x01 on detecting that the battery is fully charged.

NOTE If the Power Receiver remains in the power transfer phase, a situation could occur in which charging and power transfer indicators on the Mobile Device and Base Station, respectively, provide conflicting messages to the user. For example, the Mobile Device indicates that the battery is not charging but the Base Station indicates that power transfer is in progress. Note that the Power Receiver can restart power transfer after receiving a next Digital Ping from the Power Transmitter and the Power Receiver detecting that the charging level of the battery has dropped below some threshold.

---

<sup>8</sup> The Power Transmitter can miss the first and possibly subsequent End Power Transfer Packets, e.g. due to communications errors, and continue to apply the Power Signal. However, the Power Transmitter should eventually remove the Power Signal due to a time-out as defined in Section 5.1.2.6, *Power transfer phase*.

**Figure 33. Power Receiver timing in the *power transfer* phase**

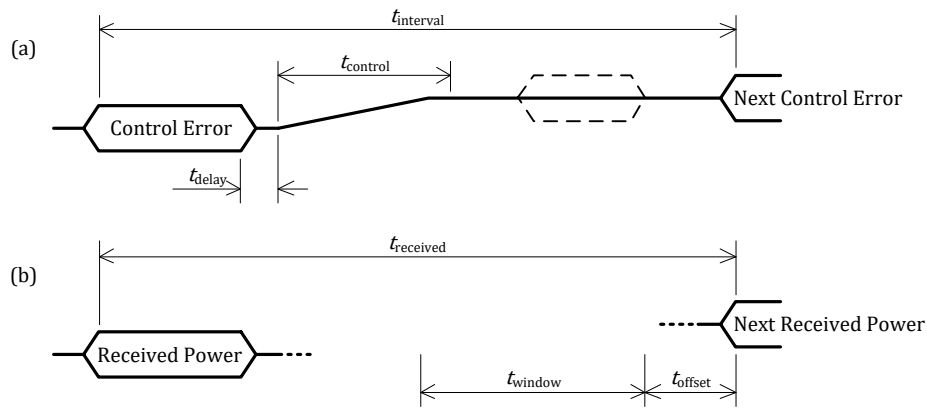

**Table 23. Power Receiver timing in the *power transfer* phase**

Parameter	Symbol	Minimum	Target	Maximum	Unit
Interval*	$t_{interval}$	—	250	350.0 <sup>+0</sup>	ms
Controller time	$t_{control}$	24.0 <sub>-0</sub>	25	N.A.	ms
Received Power Packet time	$t_{received}$	—	1500	4000.0	ms

\* The minimum possible interval depends on the value of  $t_{delay}$  and the number of preamble bits.

### 5.1.3.6.1 FOD extension support

The following applies to Power Receivers that support the FOD extensions, either as additions or changes to the above.

- A Power Receiver shall not transmit an End Power Transfer Packet with End Power Transfer Code = 0x07.
- If the Power Receiver transmits a Renegotiate Packet, it shall proceed to the *renegotiation* phase if (and only if) it receives an ACK Response.
- The Power Receiver shall transmit its first Control Error Packet within  $t_{interval}$  from
  - the start of the Configuration Packet if it reached the *power transfer* phase from the *identification & configuration* phase, or
  - from the start of the Specific Request Packet with Request = 0x00 (End Negotiation) if it reached the *power transfer* phase from the *negotiation* phase.

The Power Receiver shall continue to transmit a next Control Error Packet with a time interval  $t_{interval}$  from the start of the preceding Control Error Packet, even if it proceeds to the *renegotiation* phase in between two consecutive Control Error Packets.

- If the Maximum Power in the Power Transfer Contract exceeds 5 W, the Power Receiver shall use a  $t_{\text{received}}$  interval of at most 2.0 seconds.
- The Power Receiver shall continue to transmit a next Received Power Packet with a time interval  $t_{\text{received}}$  from the start of the preceding Received Power Packet, even if it proceeds to the *renegotiation* phase in between two consecutive Received Power Packets.
- The Power Receiver may set the Mode field of the 24-bit Received Power Packet to either '000' (normal value; Response requested) or '100' (normal value; no Response requested). An ACK Response indicates that the power transfer can continue as-is. A NAK Response indicates that the Power Receiver should reduce its power consumption.

The Power Transmitter typically sends a NAK Response in one or more of the following cases.

- It has determined that a Foreign Object has entered the magnetic field.
- It cannot support the current power level because of an increase in ambient temperature.
- It is operating close to or beyond its limits due to, for example, a low coupling condition.

In response to the NAK, the Power Receiver should:

- reduce its power consumption,
- transmit an End Power Packet with End Power Transfer Code = 0x0B (Restart Power Transfer), or
- involve the user to resolve the condition that causes the Power Transmitter to send a NAK Response.

The Power Receiver may retrieve the Power Transmitter Capability Packet to determine to what level its power consumption should be reduced.

NOTE If the Power Receiver does not request a Response after a Received Power Packet (i.e. it sets the Mode field to '100'), the Power Transmitter cannot request that the Power Receiver reduce its power consumption. Accordingly, the Power Receiver should be prepared for a power reduction initiated by Power Transmitter to occur at any time.

If it suspects that a Foreign Object may be present, it may reduce its output power, transmit an End Power Packet with End Power Transfer Code = 0x0B (Restart Power Transfer), or involve the user.

### 5.1.3.7 Renegotiation phase—FOD extensions only (PRx perspective)

In the *renegotiation* phase, the behavior of the Power Receiver shall be the same as in the *negotiation* phase, with the following exceptions.

- The Power Receiver may send a Control Error Packet, Received Power Packet, or Charge Status Packet to return to the *power transfer* phase without changing the Power Transfer Contract.
- The Power Receiver shall ensure that the last and first Control Error Packet and Received Power Packet that it sends before and after the *renegotiation* phase comply with maximum values of  $t_{\text{interval}}$  and  $t_{\text{received}}$ .
- The Power Receiver should not send an FOD Status Packet.
- The Power Receiver should not send a Specific Request Packet with Request = 0x02 (Received Power Packet Type).

### 5.1.4 State diagram (informative)

Figure 34 provides a summary of the transitions between the protocol's seven phases.

**Figure 34. State diagram**

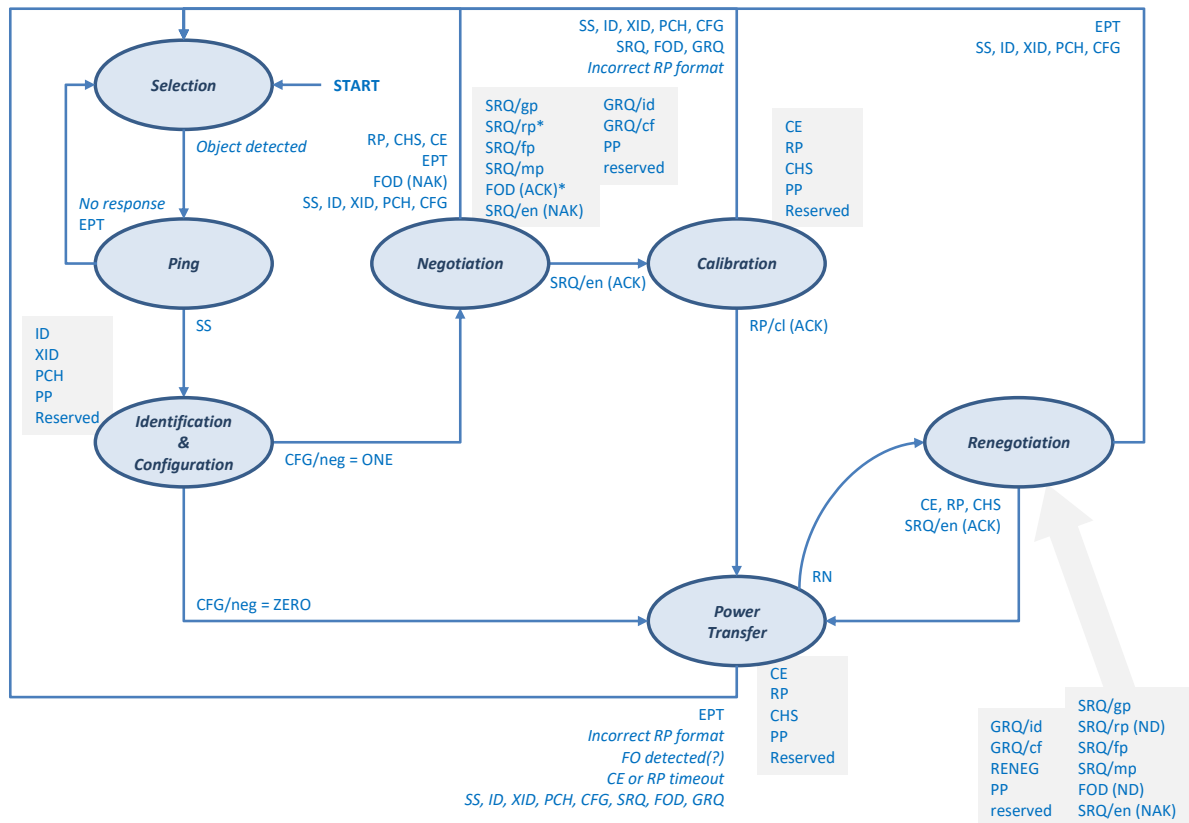

## 5.2 Power Receiver to Power Transmitter communications interface

### 5.2.1 Introduction

The Power Receiver communicates to the Power Transmitter using backscatter modulation. For this purpose, the Power Receiver modulates the amount of power that it draws from the Power Signal. The Power Transmitter detects this as a modulation of the current through and/or voltage across the Primary Cell. In other words, the Power Receiver and Power Transmitter use an amplitude modulated Power Signal to provide a Power Receiver to Power Transmitter communications channel.

### 5.2.2 Physical and data link layers (PRx to PTx)

This section defines both the physical layer and the data link layer of the Power Receiver to Power Transmitter communications interface.

#### 5.2.2.1 Modulation scheme

The Power Receiver shall modulate the amount of power that it draws from the Power Signal, such that the Primary Cell current and/or Primary Cell voltage assume two states, namely a HI state and a LO state.<sup>9</sup> A state is characterized in that the amplitude is constant within a certain variation  $\Delta$  for at least  $t_s$  ms. If the Power Receiver is properly aligned to the Primary Cell of a type A10 or MP-A1 Power Transmitter, and for all appropriate loads, at least one of the following three conditions shall apply:<sup>10</sup>

- The difference of the amplitude of the Primary Cell current in the HI and LO state is at least 15 mA.
- The difference of the Primary Cell current in the HI and LO state is at least 15 mA. The Primary Cell current is measured at instants in time that correspond to one quarter of the cycle of the control signal driving the half-bridge inverter.<sup>11</sup>
- The difference of the amplitude of the Primary Cell voltage in the HI and LO state is at least 200 mV.

During a transition the Primary Cell current and Primary Cell voltage are undefined. See Figure 35 and Table 24.

---

<sup>9</sup> NOTE The HI and LO states do not correspond to fixed Primary Cell current and/or Primary Cell voltage levels.

<sup>10</sup> The design requirements of the Mobile Device determine both the range of lateral displacements that constitute proper alignment and the range of loading conditions on its Power Receiver.

<sup>11</sup> The start of the cycle corresponds the closing of the top switch in the half-bridge inverter. See *Part 4: Reference Designs*.

**Figure 35. Amplitude modulation of the Power Signal**

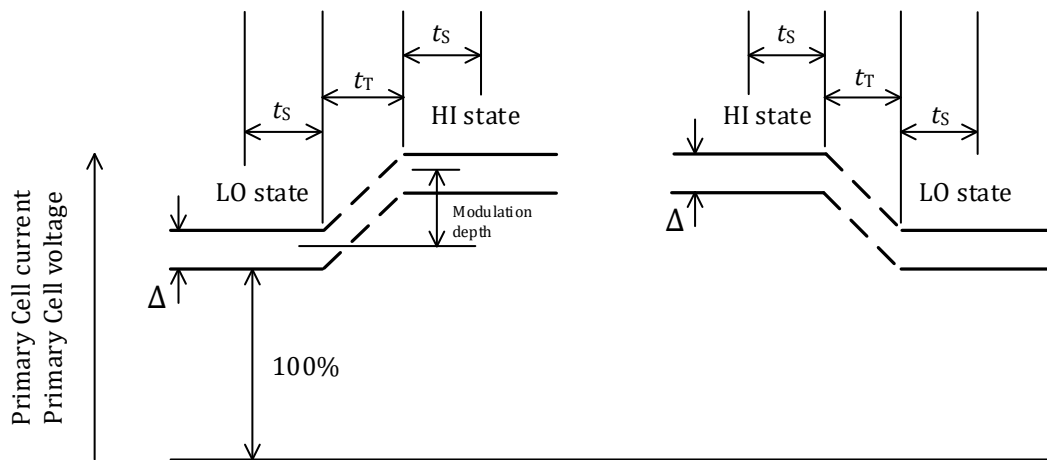

**Table 24. Amplitude modulation of the Power Signal**

Parameter	Symbol	Value	Unit
Maximum transition time	$t_T$	100	$\mu\text{s}$
Minimum stable time	$t_S$	150	$\mu\text{s}$
Current amplitude variation	$\Delta$	8	mA
Voltage amplitude variation	$\Delta$	110	mV

### 5.2.2.2 Bit encoding scheme

The Power Receiver shall use a differential bi-phase encoding scheme to modulate data bits onto the Power Signal. For this purpose, the Power Receiver shall align each data bit to a full period  $t_{CLK}$  of an internal clock signal, such that the start of a data bit coincides with the rising edge of the clock signal. This internal clock signal shall have a frequency  $f_{CLK} = 2^{\pm 4\%}$  kHz.

NOTE A ripple on the Power Receiver's load yields a ripple on the Power Transmitter's current. As a result, such a ripple can lead to bit errors in the Power Transmitter. The number of bit errors can be particularly high if this ripple has a frequency that is close to the modulation frequency  $f_{CLK}$ .

The Receiver shall encode a ONE bit using two transitions in the Power Signal, such that the first transition coincides with the rising edge of the clock signal and the second transition coincides with the falling edge of the clock signal. The Receiver shall encode a ZERO bit using a single transition in the Power Signal, which coincides with the rising edge of the clock signal.

**Figure 36. Example of a differential bi-phase encoding scheme**

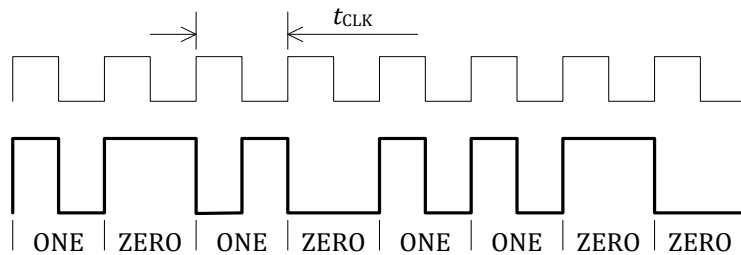

### 5.2.2.3 Byte encoding scheme

The Power Receiver shall use an 11-bit asynchronous serial format to transmit a data byte. This format consists of a start bit, the 8 data bits of the byte, a parity bit, and a single stop bit. The start bit is a ZERO. The order of the data bits is LSB first. The parity bit is odd. This means that the Power Receiver shall set the parity bit to ONE if the data byte contains an even number of ONE bits. Otherwise, the Power Receiver shall set the parity bit to ZERO. The stop bit is a ONE. Figure 37 shows the data byte format—including the differential bi-phase encoding of each individual bit—using the value 0x35 as an example.

**Figure 37. Example of the asynchronous serial format**

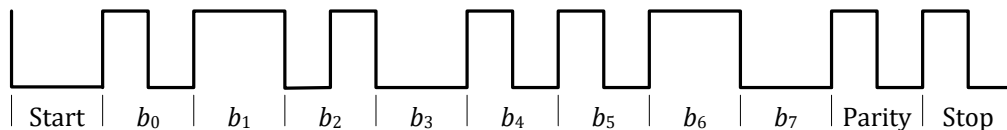

### 5.2.2.4 Packet structure

The Power Receiver shall communicate to the Power Transmitter using Packets. As shown in Figure 38, a Packet consists of 4 parts, namely a preamble, a header, a message, and a checksum. The preamble consists of a minimum of 11 and a maximum of 25 bits, all set to ONE, and encoded as defined in Section 5.2.2, *Physical and data link layers*. The preamble enables the Power Transmitter to synchronize with the incoming data and accurately detect the start bit of the header.

The header, message, and checksum consist of a sequence of three or more bytes encoded as defined in Section 5.2.2.3, *Byte encoding scheme*.<sup>12</sup>

**Figure 38. Packet format**

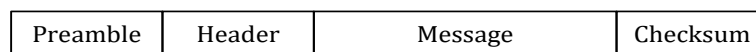

<sup>12</sup> The Power Receiver should turn off its communications modulator after transmitting a Packet. This may cause an additional HI state to LO state or LO state to HI state transition in the Primary Cell current.



The Power Transmitter shall consider a Packet as received correctly if:

- The Power Transmitter has detected at least 4 preamble bits that are followed by a start bit.
- The Power Transmitter has not detected a parity error in any of the bytes that comprise the Packet. This includes the header byte, the message bytes, and the checksum byte.
- The Power Transmitter has detected the stop bit of the checksum byte.
- The Power Transmitter has determined that the checksum byte is consistent (see Section 5.2.2.4.3, *Checksum*).

If the Power Transmitter does not receive a Packet correctly, the Power Transmitter shall discard the Packet and not use any of the information contained therein.

NOTE In the ping phase as well as in the identification and configuration phase, this typically leads to a time-out, which causes the Power Transmitter to remove the Power Signal.

#### 5.2.2.4.1 Header

The header consists of a single byte that indicates the Packet type. In addition, the header implicitly provides the size of the message contained in the Packet. The number of bytes in a message is calculated from the value contained in the header of the Packet, as shown in the center column of Table 25.

**Table 25. Message size**

Header	Message Size*	Comment
0x00...0x1F	$1 + (\text{Header} - 0) / 32$	1 × 32 messages (size 1)
0x20...0x7F	$2 + (\text{Header} - 32) / 16$	6 × 16 messages (size 2...7)
0x80...0xDF	$8 + (\text{Header} - 128) / 8$	12 × 8 messages (size 8...19)
0xE0...0xFF	$20 + (\text{Header} - 224) / 4$	8 × 4 messages (size 20...27)

\* Values in this column are truncated to an integer.

Table 26 lists the Packet types defined in this version of the Specification. The formats of the messages contained in each of these Packet types are defined in Section 5.2.3, *Logical layer*. The format of the messages contained in Packet types, which are listed as Proprietary, is implementation dependent. Header values that are not listed in Table 26 are reserved. The Power Receiver shall not transmit Packets that have one of the reserved values as the header.

**Table 26. Packet types (PRx to PTx)**

Header *	Packet Types	Message Size
0x01	Signal Strength	1
0x02	End Power Transfer	1
0x03	Control Error	1
0x04	8-bit Received Power	1
0x05	Charge Status	1
0x06	Power Control Hold-off	1
0x07	General Request	1
0x09	Renegotiate	1
0x18	Proprietary	1
0x19	Proprietary	1
0x20	Specific Request	2
0x22	FOD Status	2
0x28	Proprietary	2
0x29	Proprietary	2
0x31	24-bit Received Power	3
0x38	Proprietary	3
0x48	Proprietary	4
0x51	Configuration	5
0x54	WPID (most significant bits)	5
0x55	WPID (least significant bits)	5
0x58	Proprietary	5
0x68	Proprietary	6
0x71	Identification	7
0x78	Proprietary	7
0x81	Extended Identification	8
0x84	Proprietary	8
0xA4	Proprietary	12
0xC4	Proprietary	16
0xE2	Proprietary	20

\* Header values not listed in this table correspond to reserved Packet types.

#### 5.2.2.4.2 Message

The Power Receiver shall ensure that the message contained in the Packet is consistent with the Packet type indicated in the header. See Section 5.2.3, *Logical layer*, for a detailed definition of the possible messages. The first byte of the message, byte  $B_0$ , directly follows the header.

#### 5.2.2.4.3 Checksum

The checksum consists of a single byte that enables the Power Transmitter to check for transmission errors. The Power Transmitter shall calculate the checksum as follows:

$$C := H \oplus B_0 \oplus B_1 \oplus \dots \oplus B_{\text{last}},$$

where  $C$  represents the calculated checksum,  $H$  represents the header byte, and  $B_0, B_1, \dots, B_{\text{last}}$  represent the message bytes.

If the calculated checksum  $C$  and the checksum byte contained in the Packet are not equal, the Power Transmitter shall determine that the checksum is inconsistent.

### 5.2.3 Logical layer (PRx to PTx)

This section defines the format of the messages used by the Power Receiver to Power Transmitter communications interface.

#### 5.2.3.1 Signal Strength Packet (0x01)

Table 27 defines the format of the message contained in a Signal Strength Packet.

**Table 27. Signal strength**

	$b_7$	$b_6$	$b_5$	$b_4$	$b_3$	$b_2$	$b_1$	$b_0$
$B_0$	Signal Strength Value							

**Signal Strength Value.** The unsigned integer value in this field indicates the degree of coupling between the Primary Cell and Secondary Coil, with the purpose to enable Power Transmitters that use Free Positioning to determine the Primary Cell that provides optimum power transfer (see also Annex B, *Power Receiver Localization (Informative)*). To determine the degree of coupling, the Power Receiver shall monitor the value of a suitable variable during a Digital Ping. Examples of such variables are:

- The rectified voltage.
- The open circuit voltage (as measured at the output disconnect switch).
- The received Power (if the rectified voltage is actively or passively clamped during a Digital Ping).

The variable that is chosen shall result in a Signal Strength Value that increases monotonically with an increasing degree of coupling. The Signal Strength Value is reported as

$$\text{Signal Strength Value} = \frac{U}{U_{\max}} \cdot 256,$$

where  $U$  is the monitored variable and  $U_{\max}$  is the maximum value that the Power Receiver expects during a Digital Ping.

NOTE The Power Receiver shall set the Signal Strength Value to 255 in the case that  $U \geq U_{\max}$ .

### 5.2.3.2 End Power Transfer Packet (0x02)

Table 28 defines the format of the message contained in an End Power Transfer Packet.

**Table 28. End Power Transfer**

	<b>b<sub>7</sub></b>	<b>b<sub>6</sub></b>	<b>b<sub>5</sub></b>	<b>b<sub>4</sub></b>	<b>b<sub>3</sub></b>	<b>b<sub>2</sub></b>	<b>b<sub>1</sub></b>	<b>b<sub>0</sub></b>
<b>B<sub>0</sub></b>	End Power Transfer Code							

**End Power Transfer Code.** This field identifies the reason for the End Power Transfer request, as listed in Table 29. The Power Receiver shall not transmit End Power Transfer Packets that contain any of the values that Table 29 lists as reserved.

**Table 29. End Power Transfer values**

Reason	Value	Recommended usage of the values (Informative)
Unknown	0x00	The Receiver may use this value if it does not have a specific reason for terminating the power transfer or if none of the other values listed in this table is appropriate.
Charge Complete	0x01	The Receiver should use this value if it determines that the battery of the Mobile Device is fully charged. On receipt of an End Power Transfer Packet containing this value, the Transmitter should set any “charged” indication on its user interface that is associated with the Receiver.
Internal Fault	0x02	The Receiver may use this value if it has encountered some internal problem, e.g. a software or logic error.
Over Temperature	0x03	The Receiver should use this value if it has measured a temperature within the Mobile Device that exceeds a limit.
Over Voltage	0x04	The Receiver should use this value if it has measured a voltage within the Mobile Device that exceeds a limit.
Over Current	0x05	The Receiver should use this value if it has measured a current within the Mobile Device that exceeds a limit.
Battery Failure	0x06	The Receiver should use this value if it has determined a problem exists with the Mobile Device battery.
Reserved	0x07	The End Power Transfer Value = 0x07 (reconfigure) has been deprecated, and should not be used. It may result in unpredictable Power Transmitter behavior.
No Response	0x08	The Receiver should use this value if it determines that the Transmitter does not respond to Control Error Packets as expected (i.e. it does not increase or decrease its Primary Cell current appropriately).
Reserved	0x09	—
Negotiation Failure (Extended Power Profile only)	0x0A	A Power Receiver should use this value if it cannot negotiate a suitable Guaranteed Power level.
Restart Power Transfer (Extended Power Profile only)	0x0B	A Power Receiver should use this value if sees a need for Foreign Object Detection with no power transfer in progress (see Section 11.3, <i>FOD based on quality factor change</i> ). To enable such detection, the power transfer has to be terminated. Typically, the Power Transmitter then performs Foreign Object Detection before restarting the power transfer.
Reserved	0x0C to 0xFF	—

### 5.2.3.3 Control Error Packet (0x03)

Table 30 defines the format of the message contained in a Control Error Packet.

**Table 30. Control Error**

	<b>b<sub>7</sub></b>	<b>b<sub>6</sub></b>	<b>b<sub>5</sub></b>	<b>b<sub>4</sub></b>	<b>b<sub>3</sub></b>	<b>b<sub>2</sub></b>	<b>b<sub>1</sub></b>	<b>b<sub>0</sub></b>
<b>B<sub>0</sub></b>	Control Error Value							

**Control Error Value.** The (two's complement) signed integer value contained in this field ranges between -128...+127 (inclusive), and provides input to the Operating Point controller of the Power Transmitter. See Sections 5.1.2.6.1, *Power transfer control*, and 5.1.3.6, *Power transfer phase (PRx perspective)* for more details.

### 5.2.3.4 8-bit Received Power Packet (0x04)

Table 31 defines the format of the message contained in a Received Power Packet.

**Table 31. Received Power**

	<b>b<sub>7</sub></b>	<b>b<sub>6</sub></b>	<b>b<sub>5</sub></b>	<b>b<sub>4</sub></b>	<b>b<sub>3</sub></b>	<b>b<sub>2</sub></b>	<b>b<sub>1</sub></b>	<b>b<sub>0</sub></b>
<b>B<sub>0</sub></b>	Received Power Value							

**(FOD extensions not supported) Received Power Value.** The unsigned integer contained in this field indicates the average amount of power that the Power Receiver receives through its Interface Surface in the time window indicated in the Configuration Packet. This amount of power is calculated as follows:

$$P_{\text{received}} = \left( \frac{\text{Received Power Value}}{128} \right) \times \left( \frac{\text{Maximum Power Value}}{2} \right) \times 10^{\text{Power Class W}}.$$

Here, Maximum Power Value and Power Class are the values contained in the Configuration Packet (see Section 5.2.3.7, *Configuration Packet (0x51)*). Section 11, *Foreign Object Detection*, defines how a Power Receiver shall determine its Received Power  $P_{\text{received}}$ .

**(FOD extensions supported) Received Power Value.** The formula to calculate the Received Power  $P_{\text{received}}$  value is:

$$P_{\text{received}} = \left( \frac{\text{Received Power Value}}{128} \right) \times \text{Maximum Power}.$$

In this calculation, the Power Transmitter uses the Maximum Power that is contained in the Power Transfer Contract. The result  $P_{\text{received}}$  is in watts. Section 11, *Foreign Object Detection*, defines how a Power Receiver shall determine its Received Power  $P_{\text{received}}$ .

NOTE These formulas yield the same result regardless of whether the FOD extensions are supported. This can be understood by considering the following: the Power Class field in the Configuration Packet is always set to zero, i.e.  $10^{\text{Power Class}} = 1$ . In addition, the Maximum Power value contained in the Power Transfer Contract has a numerical value that is half of the value contained in the Maximum Power value field.

### 5.2.3.5 Charge Status Packet (0x05)

Table 32 defines the format of the message contained in a Charge Status Packet.

**Table 32. Charge Status**

	<b>b<sub>7</sub></b>	<b>b<sub>6</sub></b>	<b>b<sub>5</sub></b>	<b>b<sub>4</sub></b>	<b>b<sub>3</sub></b>	<b>b<sub>2</sub></b>	<b>b<sub>1</sub></b>	<b>b<sub>0</sub></b>
<b>B<sub>0</sub></b>	Charge Status Value							

**Charge Status Value.** If the Mobile Device contains a rechargeable energy storage device, the unsigned integer contained in this field indicates the charging level of that energy storage device as a percentage of the fully charged level. For clarity, the value 0 means an empty energy storage device and the value 100 means a fully charged energy storage device. If the Mobile Device does not contain a rechargeable energy storage device or if the Power Receiver cannot provide charge status information,<sup>13</sup> this field shall contain the value 0xFF. All other values are reserved and shall not appear in the Charge Status Packet.

### 5.2.3.6 Power Control Hold-off Packet (0x06)

Table 33 defines the format of the message contained in a Power Control Hold-off Packet.

**Table 33. Power control hold-off**

	<b>b<sub>7</sub></b>	<b>b<sub>6</sub></b>	<b>b<sub>5</sub></b>	<b>b<sub>4</sub></b>	<b>b<sub>3</sub></b>	<b>b<sub>2</sub></b>	<b>b<sub>1</sub></b>	<b>b<sub>0</sub></b>
<b>B<sub>0</sub></b>	Power Control Hold-off Time							

**Power Control Hold-off Time.** The unsigned integer contained in this field contains the amount of time in milliseconds after receipt of a Control Error Packet that the Power Transmitter shall wait before adjusting the Primary Cell current.

<sup>13</sup> NOTE The Charge Status Packet is optional, which means that the Power Receiver may elect not to send the Charge Status Packet.

### 5.2.3.7 Configuration Packet (0x51)

Table 34 defines the format of the message contained in a Configuration Packet.

**Table 34. Message in a Configuration Packet**

	b <sub>7</sub>	b <sub>6</sub>	b <sub>5</sub>	b <sub>4</sub>	b <sub>3</sub>	b <sub>2</sub>	b <sub>1</sub>	b <sub>0</sub>
<b>B<sub>0</sub></b>	Power Class		Maximum Power Value					
<b>B<sub>1</sub></b>	Reserved							
<b>B<sub>2</sub></b>	Prop	Reserved			ZERO	Count		
<b>B<sub>3</sub></b>	Window Size					Window Offset		
<b>B<sub>4</sub></b>	Neg*	Polarity*	Depth*		Reserved			

\* Applicable to the FOD extensions only. Without FOD extension support, these bits are Reserved.

**Power Class** This field shall be set to '00'.

#### Maximum Power Value

**(FOD extensions not supported)** Apart from a scaling factor, the unsigned integer value contained in this field indicates the maximum amount of power that the Power Receiver expects to provide at the output of the rectifier. This maximum amount of power is calculated as follows:

$$P_{\max} = \left( \frac{\text{Maximum Power}}{2} \right) \times 10^{\text{Power Class } W}.$$

**(FOD extensions supported)** The integer value contained in this field provides a scaling factor for the Received Power Value that a Power Receiver reports in a Received Power Packet (see also Sections 5.2.3.4, *8-bit Received Power Packet (0x04)* and 5.2.3.11, *24-bit Received Power Packet—FOD extensions only (0x31)*). A Power Receiver should set this field to twice the Maximum Power in watts that it expects to provide at its output. For backward compatibility with Power Transmitters that have been designed according to an earlier revision of this Specification, the value contained in this field shall be at most 10.

**NOTE** This value corresponds to an expected output power of 5 W. A Power Transmitter stores this value in the Power Transfer Contract, and subsequently uses that stored value to calculate the Received Power,  $P_{\text{received}}$ . If necessary, the Power Receiver can request the Power Transmitter to update the value contained in the Power Transfer Contract during the negotiation phase of the protocol (see Section 5.1.2.4, *Negotiation phase—FOD extensions only (PTx perspective)*).



**Prop** If this bit is set to ZERO, the Power Transmitter shall control the power transfer according to the method defined in Section 5.1.2.6.1, *Power transfer control*. If this bit is set to ONE, the Power Transmitter may control the power transfer according to a proprietary method instead of the method defined in Section 5.1.2.6.1. However, if this bit is set to ONE, the Power Transmitter shall continue to ensure that the received Control Error Packets comply with the timings defined in Section 5.1.2.6.

**NOTE** This implies that a Power Transmitter terminates the power transfer if it times out while waiting for a Control Error Packet. Moreover, this implies that setting the Prop bit to ONE does not relieve the Power Receiver from transmitting Control Error Packets on a regular basis. Finally, if the Prop bit is set to ZERO, the Power Transmitter could still decide to abort the power transfer based on information contained in a Proprietary Packet.

**Neg** If this bit is set to ZERO, the Power Transmitter shall refrain from sending a Response. If this bit is set to ONE, the Power Transmitter shall send an ACK Response following the end of the Configuration Packet indicating to the Power Receiver that it is entering the *negotiation* phase. See Section 5.1.2.3, *Identification & configuration phase (PTx perspective)*.

**Polarity** A ZERO in this bit indicates to the Power Transmitter to use the default FSK polarity. A ONE in this bit indicates to the Power Transmitter to use a reversed FSK polarity. See Section 5.3.2.1, *Modulation scheme*, for details.

**Depth** The unsigned integer contained in this field selects the FSK modulation depth as defined in Section 5.3.2.1.

**Reserved** These bits shall be set to ZERO.

**Count** This field contains an unsigned integer value that indicates the number of optional configuration Packets that the Power Receiver transmits in the *identification & configuration* phase.

**Window Size** The unsigned integer contained in this field indicates the window size for averaging the Received Power in units of 4 ms. Its value shall be greater than 1. See also Figure 33(b) in Section 5.1.3.6, *Power transfer phase (PRx perspective)*.

**Window Offset** The unsigned integer contained in this field indicates the interval between the window for averaging the Received Power and the transmission of the Received Power Packet, in units of 4 ms. See also Figure 33(b) in Section 5.1.3.6. To ensure that there is no overlap with the preamble, the value contained in this field shall be greater than  $n/8$ , where  $n$  represents the number of preamble bits.

### 5.2.3.8 Identification Packet (0x71)

Table 35 defines the format of the message contained in an Identification Packet.

**Table 35. Identification**

	b <sub>7</sub>	b <sub>6</sub>	b <sub>5</sub>	b <sub>4</sub>	b <sub>3</sub>	b <sub>2</sub>	b <sub>1</sub>	b <sub>0</sub>
<b>B<sub>0</sub></b>	Major Version				Minor Version			
<b>B<sub>1</sub></b>	(MSB) <span style="float: right;">(LSB)</span> Manufacturer Code							
<b>B<sub>2</sub></b>								
<b>B<sub>3</sub></b>	Ext	(MSB) <span style="float: right;">(LSB)</span> Basic Device Identifier						
⋮								
<b>B<sub>6</sub></b>								

**Major Version.** The combination of this field and the Minor Version field identifies to which revision of this Specification the Power Receiver complies. The Major Version field shall contain the binary coded digit value 0x1.

**Minor Version.** The combination of this field and the Major Version field identifies to which minor revision of this Specification the Power Receiver complies. The Minor Version field shall be set according to the power profile of the Power Receiver.

**Table 36. Minor Version field settings**

PRx Power Profile	Minor Version Setting	Neg Bit
Baseline Power Profile	0x1 or 0x2	ZERO
Baseline Power Profile with FOD Extensions	0x2	ONE
Extended Power Profile	0x2	ONE

**Manufacturer Code.** The bit string contained in this field identifies the manufacturer of the Power Receiver, as specified in the Power Receiver Manufacturer Codes, Wireless Power Consortium.

#### Ext

- If this bit is set to ZERO, the bit string  
Manufacturer Code || Basic Device Identifier  
identifies the Power Receiver.
- If this bit is set to ONE, the bit string  
Manufacturer Code || Basic Device Identifier || Extended Device Identifier  
identifies the Power Receiver (see Section 5.2.3.10, *Extended Identification Packet (0x81)*).

**Basic Device Identifier.** The bit string contained in this field contributes to the identification of the Power Receiver. A Power Receiver manufacturer should ensure that the combination of Basic Device Identifier and Manufacturer ID is sufficiently unique. Embedding a serial number of at least 20 bits in the Basic Device Identifier is sufficient. Alternatively, using a (pseudo) random number generator to dynamically generate part of the Basic Device Identifier is sufficient as well, provided that the generated part complies with the following requirements.

- The generated part shall comprise at least 20 bits.
- All possible values shall occur with equal probability.
- The Power Receiver shall not change the generated part while the Power Signal is applied.
- The Power Receiver shall retain the generated part for at least 2 seconds if the Power Signal is interrupted or removed.

NOTE These requirements ensure that the scanning procedure of a type B1 Power Transmitter proceeds correctly. See Annex B.2, *Primary Coil array based Free Positioning*.

### 5.2.3.9 Wireless Power ID Packets (0x54 and 0x55)

Table 37 shows the format of the message payload contained in the Wireless Power Identification Packets.

**Table 37. WP Identification Packets**

	b <sub>7</sub>	b <sub>6</sub>	b <sub>5</sub>	b <sub>4</sub>	b <sub>3</sub>	b <sub>2</sub>	b <sub>1</sub>	b <sub>0</sub>
<b>B<sub>0</sub></b>	WPID							
<b>B<sub>1</sub></b>								
<b>B<sub>2</sub></b>								
<b>B<sub>3</sub></b>	CRC							
<b>B<sub>4</sub></b>								

The fields of these data Packets have the following purpose:

- **CRC**—unsigned integer. This field shall contain the Cyclic Redundancy Check (CRC) of the WPID field in this Packet. The CRC-16 value shall be calculated as defined in Section 5.2.3.9.1.
- **WPID**—bit string. This field shall contain the 24 most significant bits (Packet 0x54) or the 24 least significant bits (Packet 0x55) of the identifier that uniquely identifies the Power Receiver. For more information, see Section 5.1.3.4.2.4.

### 5.2.3.9.1 CRC calculation

The calculation shall use the polynomial that is represented by the bit string ‘1000000100001’ (or 0x1021; and in its reverse form 0x8408)—also known as CRC-16-CCITT. The CRC value shall be determined as the remainder of the following long division:

$$\frac{\text{'1111111111111111'} \parallel \text{WPID} \parallel \text{'0000000000000000'}}{0x1021},$$

where the string of 16 ONES represents the initial value, WPID represents the 24-bit string contained in the Wireless Power ID Packet, and the string of 16 ZEROS represents the padding. As an example, the CRC value calculated from the WPID bit string 0xABCDEF is 0x30A8.

### 5.2.3.10 Extended Identification Packet (0x81)

Table 38 defines the format of the message contained in an Extended Identification Packet.

**Table 38. Extended Identification**

	b <sub>7</sub>	b <sub>6</sub>	b <sub>5</sub>	b <sub>4</sub>	b <sub>3</sub>	b <sub>2</sub>	b <sub>1</sub>	b <sub>0</sub>
<b>B<sub>0</sub></b>	Extended Device Identifier							
⋮								
<b>B<sub>7</sub></b>								

(MSB) (LSB)

**Extended Device Identifier.** The bit string contained in this field contributes to the identification of the Power Receiver. See Section 5.2.3.8.

### 5.2.3.11 24-bit Received Power Packet—FOD extensions only (0x31)

Table 39 defines the format of the message contained in a Received Power Packet.

**Table 39. Message in a 24-bit Received Power Packet**

	b <sub>7</sub>	b <sub>6</sub>	b <sub>5</sub>	b <sub>4</sub>	b <sub>3</sub>	b <sub>2</sub>	b <sub>1</sub>	b <sub>0</sub>
<b>B<sub>0</sub></b>	Reserved				Mode			
<b>B<sub>1</sub></b>	Received Power Value							
<b>B<sub>2</sub></b>								

(MSB) (LSB)

**Mode.** The bit string in this field provides additional information with respect to the Received Power Value.

**Table 40. Mode field values**

Mode	Description
'000'	Normal value; Response requested
'001'	Light-load calibration value; Response requested
'010'	Connected-load calibration value; Response requested
'011'	Reserved
'100'	Normal value; no Response expected
'101'	Reserved
'110'	Reserved
'111'	Reserved

**Reserved.** These bits shall be set to ZERO.

**Received Power Value.** The unsigned integer contained in this field indicates the average amount of power,  $P_{\text{received}}$ , that the Power Receiver receives through its Interface Surface in the time window indicated in the Configuration Packet. This is expressed as

$$P_{\text{received}} = \left( \frac{\text{Received Power Value}}{32768} \right) \times \text{Maximum Power.}$$

In this calculation, the Power Transmitter uses the Maximum Power that is contained in the Power Transfer Contract. The result for  $P_{\text{received}}$  is in watts. Section 11, *Foreign Object Detection*, defines how a Power Receiver shall determine its Received Power,  $P_{\text{received}}$ .

### 5.2.3.12 General Request Packet—FOD extensions only (0x07)

Table 41 defines the format of the message contained in a General Request Packet.

**Table 41. Message in a General Request Packet**

	b <sub>7</sub>	b <sub>6</sub>	b <sub>5</sub>	b <sub>4</sub>	b <sub>3</sub>	b <sub>2</sub>	b <sub>1</sub>	b <sub>0</sub>
<b>B<sub>0</sub></b>	Request							

**Request.** This unsigned integer value indicates the kind of information that is requested. To request a particular Packet, set the Request field to the header of that Packet. For example, to request a Power Transmitter Identification Packet, set the Request field to 0x30. See Table 54 for a list of Packet headers. See Section 5.3.3, *Logical layer (PTx to PRx)* for the format of the Packets that the Power Transmitter sends in return.

### 5.2.3.13 Specific Request Packet—FOD extensions only (0x20)

Table 42 defines the format of the message contained in a Specific Request Packet.

**Table 42. Message in a Specific Request Packet**

	<b>b<sub>7</sub></b>	<b>b<sub>6</sub></b>	<b>b<sub>5</sub></b>	<b>b<sub>4</sub></b>	<b>b<sub>3</sub></b>	<b>b<sub>2</sub></b>	<b>b<sub>1</sub></b>	<b>b<sub>0</sub></b>
<b>B<sub>0</sub></b>	Request							
<b>B<sub>1</sub></b>	Request Parameter							

**Request.** The unsigned integer in this field contains the request, as defined in Table 43. See Section 5.1.2.4.2.1, *Specific Request Packet*, for details on the expected Response from a Power Transmitter.

**Request Parameter.** This field contains a parameter of the request. See the following subsections for details.

**Table 43. Request field values**

Request	Description	Request Parameter
0x00	End Negotiation	Change count
0x01	Guaranteed Power	Guaranteed Power Value
0x02	Received Power Packet Type	Received Power Packet Header
0x03	FSK Parameters	Polarity and depth
0x04	Maximum Power	Maximum Power Value
0x05 to 0xEF	Reserved	N.A.
0xF0 to 0xFF	Proprietary	Proprietary

#### 5.2.3.13.1 End Negotiation (0x00)

Table 44 defines the format of the Request Parameter field contained in the Specific Request Packet.

**Table 44. Format of the Request Parameter field**

	<b>b<sub>7</sub></b>	<b>b<sub>6</sub></b>	<b>b<sub>5</sub></b>	<b>b<sub>4</sub></b>	<b>b<sub>3</sub></b>	<b>b<sub>2</sub></b>	<b>b<sub>1</sub></b>	<b>b<sub>0</sub></b>
<b>B<sub>1</sub></b>	Change Count							

**Change Count.** The unsigned integer value contained in this field provides a count of the number of parameters in the Power Transfer Contract that have been modified during the *negotiation* phase.

### 5.2.3.13.2 Guaranteed Power (0x01)

Table 45 defines the format of the Request Parameter field contained in the Specific Request Packet.

**Table 45. Format of the Request Parameter field**

	<b>b<sub>7</sub></b>	<b>b<sub>6</sub></b>	<b>b<sub>5</sub></b>	<b>b<sub>4</sub></b>	<b>b<sub>3</sub></b>	<b>b<sub>2</sub></b>	<b>b<sub>1</sub></b>	<b>b<sub>0</sub></b>
<b>B<sub>1</sub></b>	Reserved		Guaranteed Power Value					

**Guaranteed Power Value.** This field contains the requested amount of Guaranteed Power in units of 0.5 W. For example, the value 10 serves to query if the Power Transmitter supports a Guaranteed Power of 5 W, and the value 30 queries for a Guaranteed Power of 15 W. Based on the Power Transmitter designs defined in *Part 4: Reference Designs*, a Power Receiver should not attempt to negotiate for a Guaranteed Power greater than 15 W.

**Reserved.** These bits shall be set to ZERO.

### 5.2.3.13.3 Received Power Packet Type (0x02)

Table 46 defines the format of the Request Parameter field contained in the Specific Request Packet.

**Table 46. Format of the Request Parameter field**

	<b>b<sub>7</sub></b>	<b>b<sub>6</sub></b>	<b>b<sub>5</sub></b>	<b>b<sub>4</sub></b>	<b>b<sub>3</sub></b>	<b>b<sub>2</sub></b>	<b>b<sub>1</sub></b>	<b>b<sub>0</sub></b>
<b>B<sub>1</sub></b>	Received Power Packet Header							

**Received Power Packet Header.** This field shall be set to 0x31 to indicate that the Power Receiver intends to use the 24-bit Received Power Packet in the *power transfer* phase.

### 5.2.3.13.4 FSK Parameters (0x03)

Table 47 defines the format of the Request Parameter field contained in the Specific Request Packet.

**Table 47. Format of the Request Parameter field**

	<b>b<sub>7</sub></b>	<b>b<sub>6</sub></b>	<b>b<sub>5</sub></b>	<b>b<sub>4</sub></b>	<b>b<sub>3</sub></b>	<b>b<sub>2</sub></b>	<b>b<sub>1</sub></b>	<b>b<sub>0</sub></b>
<b>B<sub>1</sub></b>	Reserved					Polarity	Depth	

**Polarity.** A ZERO in this bit indicates to the Power Transmitter to use the default FSK polarity. A ONE in this bit indicates to the Power Transmitter to use a reversed FSK polarity. See Section 5.3.2.1, *Modulation scheme*, for details.

**Depth.** The unsigned integer contained in this field selects the FSK modulation depth as defined in Section 5.3.2.1.

**Reserved.** These bits shall be set to ZERO.

### 5.2.3.13.5 Maximum Power (0x04)

Table 48 defines the format of the Request Parameter field contained in the Specific Request Packet.

**Table 48. Format of the Request Parameter field**

	<b>b<sub>7</sub></b>	<b>b<sub>6</sub></b>	<b>b<sub>5</sub></b>	<b>b<sub>4</sub></b>	<b>b<sub>3</sub></b>	<b>b<sub>2</sub></b>	<b>b<sub>1</sub></b>	<b>b<sub>0</sub></b>
<b>B<sub>1</sub></b>	Reserved		Maximum Power Value					

**Maximum Power Value.** The integer value contained in this field provides an updated scaling factor for the Received Power Value that a Power Receiver reports in a Received Power Packet (see also Sections 5.2.3.4, *8-bit Received Power Packet (0x04)* and 5.2.3.11, *24-bit Received Power Packet—FOD extensions only (0x31)*). A Power Receiver should set this value to the twice the maximum amount of power in watts that it expects to provide at its output (see Section 5.2.3.7, *Configuration Packet (0x51)*).

**Reserved.** These bits shall be set to ZERO.

### 5.2.3.14 FOD Status Packet—FOD extensions only (0x22)

Table 49 defines the format of the message contained in an FOD Status Packet.

**Table 49. Message in an FOD Status Packet**

	<b>b<sub>7</sub></b>	<b>b<sub>6</sub></b>	<b>b<sub>5</sub></b>	<b>b<sub>4</sub></b>	<b>b<sub>3</sub></b>	<b>b<sub>2</sub></b>	<b>b<sub>1</sub></b>	<b>b<sub>0</sub></b>
<b>B<sub>1</sub></b>	Reserved						Mode	
<b>B<sub>2</sub></b>	Reference Quality Factor Value							

**Mode.** This field indicates the operating mode of the Power Receiver in which the Reference Quality Factor Value applies.

**Table 50. Mode field values**

<b>Mode</b>	<b>Description</b>
'00'	The Power Receiver is powered off
'01'	Reserved
'10'	Reserved
'11'	Reserved

**Reserved.** These bits shall be set to ZERO.

**Reference Quality Factor Value.** The unsigned integer in this field contains Reference Quality Factor of the Power Receiver. See Section 11.3, *FOD based on quality factor change*, for details.



### 5.2.3.15 Renegotiate Packet—FOD extensions only (0x09)

Table 51 defines the format of the message contained in a Renegotiate Packet.

**Table 51. Message in a Renegotiate Packet**

	<b>b<sub>7</sub></b>	<b>b<sub>6</sub></b>	<b>b<sub>5</sub></b>	<b>b<sub>4</sub></b>	<b>b<sub>3</sub></b>	<b>b<sub>2</sub></b>	<b>b<sub>1</sub></b>	<b>b<sub>0</sub></b>
<b>B<sub>0</sub></b>	Reserved							

**Reserved.** These bits shall be set to ZERO.

## 5.3 Power Transmitter to Power Receiver communications interface

### 5.3.1 Introduction

The Power Transmitter communicates to the Power Receiver using Frequency Shift Keying, in which the Power Transmitter modulates the Operating Frequency of the Power Signal.

### 5.3.2 Physical and data link layers (PTx to PRx)

This section defines both the physical layer and the data link layer of the Power Transmitter to Power Receiver communications interface. The data link layer supports both Packets and Responses. The format of a Packet is defined in Section 5.3.2.3. The format of a Response is defined in Section 5.3.2.4.

#### 5.3.2.1 Modulation scheme

The Power Transmitter shall switch its Operating Frequency between the Operating Frequency  $f_{op}$  in the unmodulated state and the Operating Frequency  $f_{mod}$  in the modulated state. The difference between these two frequencies is characterized by two parameters:

- *Polarity*. This parameter determines whether the difference between  $f_{mod}$  and  $f_{op}$  is positive or negative.

NOTE In both the Configuration Packet and a Specific Request Packet that has its Request field set to 0x03 (FSK Parameters), the Power Receiver encodes the positive polarity as a ZERO and the negative polarity as a ONE. In addition, note that a negative polarity typically increases the voltage induced in the Secondary Coil, and therefore should be used with care.

- *Depth*. This parameter determines the magnitude of the difference between  $f_{op}$  and  $f_{mod}$ .

NOTE Both the Configuration Packet and the Specific Request Packet (Request 0x03, FSK Parameters) encode the modulation depth in a two-bit unsigned integer value.

For any given Operating Frequency  $f_{op}$ , and depending on the polarity and depth parameters,  $f_{mod}$  shall be chosen such that the time difference between a single cycle of  $f_{mod}$  and a single cycle of  $f_{op}$  is in the range that is defined in Table 52.

NOTE The minimum time difference in this Table corresponds to a single cycle of a 32 MHz clock.

**Table 52. FSK States**

Polarity	Depth	$\frac{1}{f_{\text{mod}}} - \frac{1}{f_{\text{op}}}$		Unit
		Minimum	Maximum	
positive	3	-282.00	-249.00	ns
positive	2	-157.00	-124.00	ns
positive	1	-94.50	-61.50	ns
positive	0	-63.25	-30.25	ns
negative	0	30.25	63.25	ns
negative	1	61.50	94.50	ns
negative	2	124.00	157.00	ns
negative	3	249.00	282.00	ns

### 5.3.2.2 Bit encoding scheme

The Power Transmitter shall use a differential bi-phase encoding scheme to modulate data bits in the Power Signal. For this purpose, the Power Transmitter shall align each data bit to 512 cycles of the Power Signal frequency.

The Power Transmitter shall encode a ONE bit using two transitions in the Power Signal frequency. The first transition shall occur at the start of the bit and the second transition shall occur at 256 cycles into the bit. The Transmitter shall encode a ZERO bit using a single transition in the Power Signal frequency at the start of the bit.

**Figure 39. Example of differential bi-phase encoding**

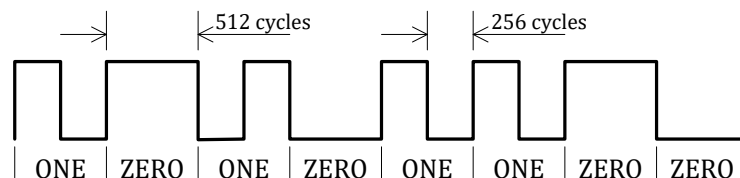

### 5.3.2.3 Packet structure

The Power Transmitter shall communicate to the Power Receiver using Packets. A Packet consists of a series of bytes that the Power Transmitter shall send as a contiguous sequence, i.e. there shall be no pauses in between two consecutive bytes. Section 5.3.2.3.1 defines the format of a byte. As shown in Figure 40, a Packet consists of three parts, a header, a message, and a checksum. The header, message, and checksum consist of a sequence of three or more bytes encoded as defined in 5.3.2.3.1.

**Figure 40. Packet format**

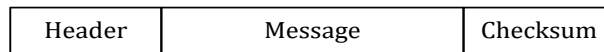

The Power Receiver shall consider a Packet as received correctly if:

- The Power Receiver has not detected a parity error in any of the bytes that comprise the Packet. This includes the header byte, the message bytes and the checksum byte.
- The Power Receiver has detected the stop bit of the checksum byte.
- The Power Receiver has determined that the checksum byte is consistent (see Section 5.3.2.3.4, *Checksum*).

If the Power Receiver does not receive a Packet correctly, the Power Receiver shall discard the Packet and not use any of the information contained therein.

#### 5.3.2.3.1 Byte encoding scheme

The Power Transmitter shall use an 11-bit asynchronous serial format to transmit a data byte. This format consists of a start bit, the 8 data bits of the byte, a parity bit, and a single stop bit. The start bit is a ZERO. The order of the data bits is LSB first. The parity is even, which means that the Power Transmitter shall set the parity bit to ONE if the data byte contains an odd number of ONE bits. Otherwise, the Power Transmitter shall set the parity bit to ZERO.

NOTE For clarity, Power Receiver to Power Transmitter communications use odd parity, as defined in Section 5.2.2.3, *Byte encoding scheme*.

The stop bit is a ONE. Figure 41 shows the data byte format—including the differential bi-phase encoding of each individual bit—using the value 0x35 as an example. The Power Transmitter shall send all bits in a contiguous sequence without a pause in between two consecutive bits. It shall send the start bit first and the stop bit last.

**Figure 41. Example of the asynchronous serial format**

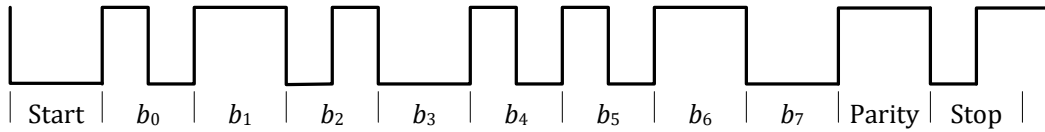

### 5.3.2.3.2 Header

The header consists of a single byte that indicates the Packet type. In addition, the header implicitly provides the size of the message contained in the Packet. The number of bytes in a message is calculated from the value contained in the header of the Packet, as is shown in the center column of Table 53.

**Table 53. Message size**

Header	Message Size*	Comment
0x00 to 0x1F	$1 + (\text{Header} - 0) / 32$	1 × 32 messages (size 1)
0x20 to 0x7F	$2 + (\text{Header} - 32) / 16$	6 × 16 messages (size 2 to 7)
0x80 to 0xDF	$8 + (\text{Header} - 128) / 8$	12 × 8 messages (size 8 to 19)
0xE0 to 0xFF	$20 + (\text{Header} - 224) / 4$	8 × 4 messages (size 20 to 27)

\*Values in the Message Size column are truncated to an integer.

Table 54 lists the Packet types defined in this Specification. The formats of the messages contained in each of these Packet types are defined in Section 5.3.3, *Logical layer (PTx to PRx)*. The format of the messages contained in Packet types that are listed as Proprietary is implementation dependent. Header values that are not listed in Table 54 are reserved. The Power Transmitter shall not transmit Packets that have one of the reserved values as a header.

**Table 54. Packet Types (PTx to PRx)**

Header*	Packet Types	Message Size
Negotiation phase		
0x00	Power Transmitter Data Not Available	1
0x1E	Proprietary	1
0x1F	Proprietary	1
0x2E	Proprietary	2
0x2F	Proprietary	2
0x30	Power Transmitter Identification	3
0x31	Power Transmitter Capability	3
0x3F	Proprietary	3
0x4F	Proprietary	4
0x5F	Proprietary	5
0x6F	Proprietary	6
0x7F	Proprietary	7
0x8F	Proprietary	9

\*Header values not listed in this table correspond to Reserved Packet types.

### 5.3.2.3.3 Message

The Power Transmitter shall ensure that the message contained in the Packet is consistent with the Packet type indicated in the header. See Section 5.3.3 for a detailed definition of the possible messages. The first byte of the message, byte  $B_0$ , directly follows the header.

### 5.3.2.3.4 Checksum

The checksum consists of a single byte that enables the Power Receiver to check for transmission errors. The Power Transmitter shall calculate the checksum as follows,

$$C := H \oplus B_0 \oplus B_1 \oplus \dots \oplus B_{\text{last}}$$

where  $C$  represents the calculated checksum,  $H$  represents the header byte, and  $B_0, B_1, \dots, B_{\text{last}}$  represent the message bytes.

If the calculated checksum  $C$  and the checksum byte contained in the Packet are not equal, the Power Receiver shall determine that the checksum is inconsistent.

### 5.3.2.4 Response structure

A Response consists of eight consecutive bits. Table 55 defines the Responses.

Figure 42 shows the format of a Response.

NOTE Unlike a byte (see Section 5.3.2.3.1, *Byte encoding scheme*), a Response does not include a start bit, a parity bit, and a stop bit. Due to the repeating pattern of a Response, a Power Receiver can use a relatively simple decoding logic to distinguish between the three different Responses.

**Table 55. Format of a Response**

	Message	Description	Format
ACK	Acknowledge	Accept a request	'11111111'
NAK	Not-Acknowledge	Deny a request	'00000000'
ND	Not-Defined	Unrecognized or invalid request	'01010101'

**Figure 42. Format of the three defined Responses**

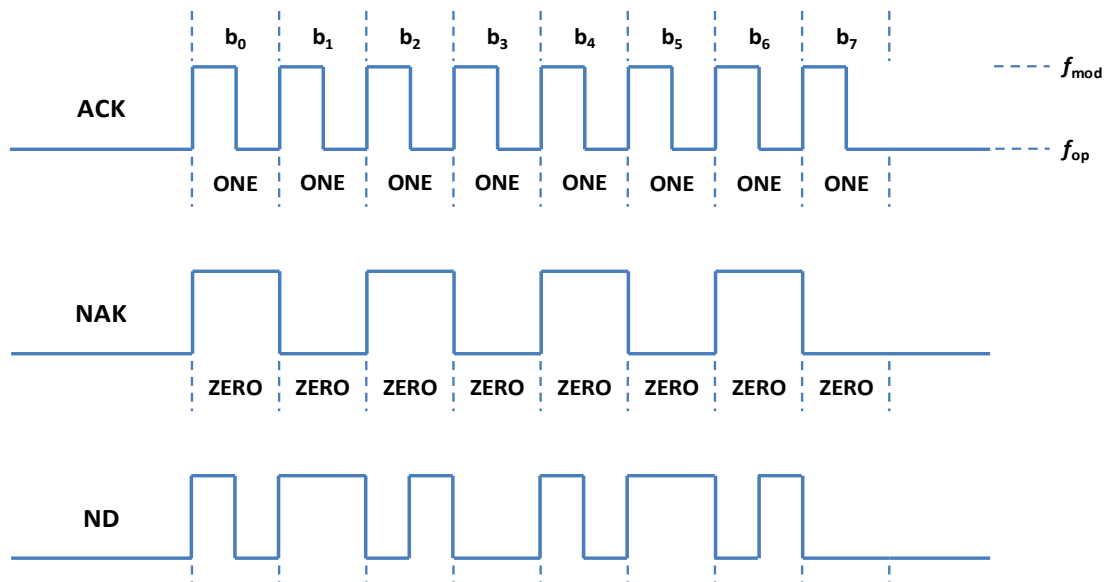

### 5.3.3 Logical layer (PTx to PRx)

This section defines the format of the messages of the Power Transmitter to Power Receiver communications interface.

#### 5.3.3.1 Power Transmitter data not available Packet (0x00)

Table 56 defines the format of the message contained in the Power Transmitter Data Not Available Packet.

**Table 56. Power Transmitter Data Not Available**

	b <sub>7</sub>	b <sub>6</sub>	b <sub>5</sub>	b <sub>4</sub>	b <sub>3</sub>	b <sub>2</sub>	b <sub>1</sub>	b <sub>0</sub>
B <sub>0</sub>	Reserved							

**Reserved.** These bits shall be set to ZERO.

#### 5.3.3.2 Power Transmitter Identification Packet (0x30)

Table 57 defines the format of the message contained in the Power Transmitter Identification Packet.

**Table 57. Power Transmitter Identification**

	b <sub>7</sub>	b <sub>6</sub>	b <sub>5</sub>	b <sub>4</sub>	b <sub>3</sub>	b <sub>2</sub>	b <sub>1</sub>	b <sub>0</sub>
B <sub>0</sub>	Major Version				Minor Version			
B <sub>1</sub>	Manufacturer Code							
B <sub>2</sub>								

**Major Version.** The combination of this field and the Minor Version field identifies to which revision of this Specification the Power Transmitter complies. The Major Version field shall contain the binary coded digit value 0x1.

**Minor Version.** The combination of this field and the Major Version field identifies to which minor revision of this Specification the Power Transmitter complies. The Minor Version field shall contain the binary coded digit value 0x2.

**Manufacturer Code.** The bit string contained in this field identifies the manufacturer of the Power Transmitter, as specified in the Power Receiver Manufacturer Codes, Wireless Power Consortium.



### 5.3.3.3 Power Transmitter Capability Packet (0x31)

Table 58 defines the format of the message contained in a Power Transmitter Capability Packet.

**Table 58. Power Transmitter Capability**

	b <sub>7</sub>	b <sub>6</sub>	b <sub>5</sub>	b <sub>4</sub>	b <sub>3</sub>	b <sub>2</sub>	b <sub>1</sub>	b <sub>0</sub>
<b>B<sub>0</sub></b>	Power Class		Guaranteed Power Value					
<b>B<sub>1</sub></b>	Reserved		Potential Power Value					
<b>B<sub>2</sub></b>	Reserved						WPID	Not Res Sens

**Power Class.** This field shall be set to '00'.

**Guaranteed Power Value.** This field identifies the maximum Guaranteed Power value contained in the Power Transfer Contract (PTC-GP) that the Power Transmitter is willing to negotiate under *current* ambient conditions.

Examples of ambient conditions are:

- The temperature of the Power Transmitter
- The amount of power that a Power Transmitter can drain from a power source that is shared with other Power Transmitters
- The presence or absence of Foreign Objects or Friendly Metal

The value in this field is in units of 0.5 W. For example, this field will display a value of 30 for a 15 W Power Transmitter operating in a normal temperature range and with sufficient input power to operate at 15 W. If the ambient temperature rises excessively or other Power Transmitters are added to the same power circuit, this field may drop down to a value of 10, indicating that a maximum of 5 W can be used under the current circumstances. Additional examples are in sections 5.3.3.3.1 and 5.3.3.3.2.

**Potential Power Value.** This field identifies the maximum Guaranteed Power value contained in the Power Transfer Contract (PTC-GP) that the Power Transmitter is willing to negotiate under *ideal* ambient conditions. The value in this field is in units of 0.5 W.

**NOTE** The Power Receiver should not rely on continuously receiving power that exceeds the PTC-GP. The Power Transmitter may reduce the power available at any time, due to insufficient input power, over-heating, or other circumstances.

**Not Res Sens.** The individual Power Transmitter designs in *Part 4: Reference Designs* each define the setting of this bit.

**NOTE** As a general rule, this bit shall be set to ZERO for Power Transmitter designs that enable frequency control below 150 kHz with a Power Transmitter Contract that contains a Maximum Power value greater than 5 W. The

background of this bit is that at higher power levels the system resonant frequency can shift—especially if the Power Receiver’s Shielding becomes saturated. This may cause complications if the system resonant frequency becomes greater than the Operating Frequency. Consequently, knowledge of the Power Transmitter’s control method may be utilized by Power Receivers that are sensitive to this situation, for example, to limit their output power if placed on a Power Transmitter that uses frequency control. Power Receiver designs that do not exhibit this sensitivity, such as those with thicker Shielding, may ignore this bit.

**Reserved.** These bits shall be set to ZERO.

**WPID.** This bit indicates to a Power Receiver that the Power Transmitter is capable of receiving the WPID packets.

### 5.3.3.3.1 Example of power transfer process under normal conditions

Table 59 shows the steps in the power transfer process and the power values established under normal conditions, i.e. adequate power to drive the PTx at its rated operation and normal ambient temperature.

**Table 59. Power transfer process under normal conditions**



Power transfer step	PTC-GP	GPV	PPV	TP
0. Normal power condition detected	N.A.	15 W	15 W	0
1. Start negotiation	5 W	15 W	15 W	< 5 W
2. Request PTx Capability Packet	5 W	15 W	15 W	< 5 W
3. Request 15 W GP ACK’ed	(15 W)	15 W	15 W	< 5 W
4. Other negotiation Packet(s)—Optional	(15 W)	15 W	15 W	< 5 W
5. End negotiation ACK’ed	15 W	15 W	15 W	< 5 W
6. Target reached	15 W	15 W	15 W	~ 15 W
15. End power	N.A.	15 W	15 W	0

**PTC-GP** is the Guaranteed Power value in the Power Transfer Contract

**GPV** is the Guaranteed Power Value identified in the Power Transmitter Capability Packet

**PPV** is the Potential Power Value identified in the Power Transmitter Capability Packet

**TP** is the Transmitted Power measured by the Power Transmitter

### 5.3.3.3.2 Example of complete power transfer process with multiple events

Table 60 shows the steps in the power transfer process when multiple events occur. First, insufficient power is detected at startup, but later the condition is resolved. Insufficient power typically occurs when:

- the PTx is operating from a limited power source,
- the PTx is operating from a shared power source, and most of the power has already been allocated to another PTx, or
- operating at full power would lead to overheating.

At step 7, the PRx checks to see if the PTx is still in an insufficient power condition. In steps 8-10 the condition is resolved and full power is restored. In step 11, the PRx signals that full power is no longer needed, perhaps due to a nearly-full battery or the PRx is getting too warm. The PTx scales back accordingly until the PRx signals in step 15 that it no longer needs to draw any power.

**Table 60. Power transfer process with multiple events**

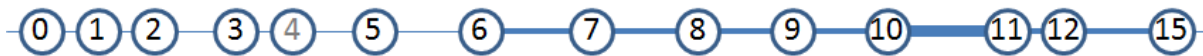

Power transfer step	PTC-GP	GPV	PPV	TP
0. Reduced power condition detected	N.A.	5 W	12 W	0
1. Start negotiation	5 W	5 W	12 W	< 5 W
2. Request PTx Capability Packet	5 W	5 W	12 W	< 5 W
3. Request 12 W GP NAK'ed	5 W	5 W	12 W	< 5 W
4. Other negotiation Packet(s)—Optional	5 W	5 W	12 W	< 5 W
5. End negotiation ACK'ed	5 W	5 W	12 W	< 5 W
6. Target reached	5 W	5 W	12 W	~ 5 W
7. Request PTx Capability Packet	5 W	5 W	12 W	~ 5 W
8. Reduced power condition resolved	5 W	12 W	12 W	~ 5 W
9. Request PTx Capability Packet	5 W	12 W	12 W	~ 5 W
10. Renegotiate 12 W GP & reach target	12 W	12 W	12 W	~ 12 W
11. Full Power no longer needed	12 W	12 W	12 W	~ 5 W
12. Voluntarily renegotiate 5 W GP	5 W	12 W	12 W	~ 5 W
15. End power	N.A.	12 W	12 W	0

## **PART 2: Secondary Interface Definition**

## 6 External Power Input (Informative)

### 6.1 Available power—Extended Power Profile only

To meet the recommended minimum system efficiency (see Section 8.2, *Power Transmitter efficiency*), the power supply of a Power Transmitter should be able to provide at least 20 W.

Once the Power Transmitter has completed the *negotiation* phase, and therefore has established a Power Transfer Contract, its power supply should not reduce the power below the level that is necessary to fulfil the Guaranteed Power in the Power Transfer Contract. Note that this provision typically is relevant only if multiple Power Transmitters share a single power supply. For example, if two Power Transmitters share a single 30 W power supply, only one of the two at a time can negotiate a Guaranteed Power of 15 W—which translates to an input power of 20 W or more. The other one then has to stick to a Guaranteed Power of 5 W—which translates to an input power of 7.5 W or more. In order to make this work reliably, some communication should be provided between the Power Transmitters and the power supply.

## 7 Power Levels—Extended Power Profile only

### 7.1 Guaranteed Power

The Power Transmitter designs using the Extended Power Profile and defined in *Part 4: Reference Designs* can support a Guaranteed Power of 15 W. A Power Transmitter that is constructed according to one of these Power Transmitter designs can provide the amount of power that Test Power Receiver #MP1 needs to function at its intended Control Point. In particular, this means that if Test Power Receiver #MP1 is positioned appropriately relative to the Power Transmitter, it can provide

- 8 W of power at its output in configuration A;
- 15 W of power at its output in configuration B; and
- 12 W of power at its output in configuration C.

### 7.2 Light load

A Power Transmitter shall be able to continuously provide power at 5% of the Maximum Power level that is contained in the Power Transfer Contract, with a minimum of 250 mW.

**NOTE** Power Receivers that operate in stand-by mode, or have a nearly full battery may present such a light load to the Power Transmitter for longer periods of time. The minimum light-load power level that a Power Transmitter is required to support corresponds to a negotiated Maximum Power level of 5 W.

## 8 System Efficiency (Informative)

The efficiency of a wireless power transfer System depends on the combination of the specific Power Transmitter and the specific Power Receiver that are used, as well as their alignment. Since the Power Transmitter and Power Receiver are subsystems of two separate pieces of end equipment that may originate from different manufacturers, the efficiency of each can only be measured with a reference test fixture of the other subsystem. Below defines the procedure to measure the system efficiency with the help of the Test Power Transmitters and Test Power Receivers, which are defined in *Part 3: Compliance Testing*.

### 8.1 Definition

Figure 43 shows a schematic diagram of a wireless power transfer System, consisting of a Power Transmitter coupled to a Power Receiver. As illustrated,  $P_{in}$  represents the DC input power to the (inverter stage of the) Power Transmitter, and  $P_{OL}$  represents the amount of DC power that is consumed in the load that is connected to the output terminals of the Power Receiver. The system efficiency is defined as:

$$\eta_{system} = \frac{P_{OL}}{P_{in}}$$

**Figure 43. System efficiency**

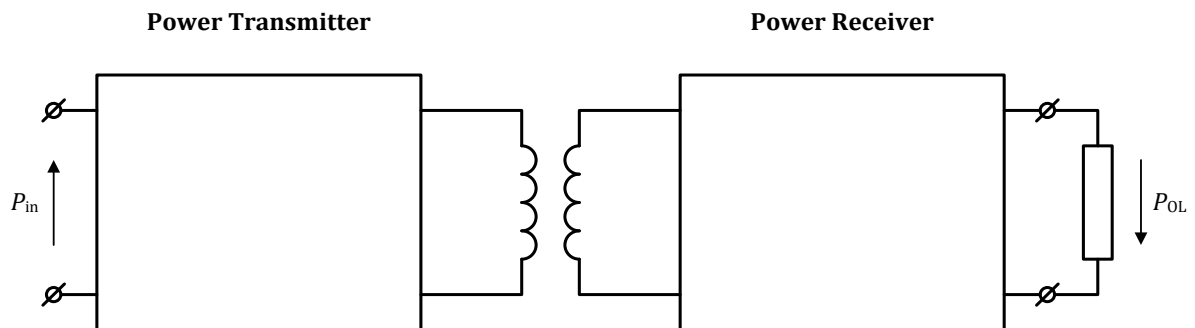

## 8.2 Power Transmitter efficiency

### 8.2.1 Baseline Power Profile

Table 61 indicates the recommended minimum system efficiency of a Power Transmitter for Baseline Power Profile devices, as measured with the set of Test Power Receivers defined in *Part 3: Compliance Testing*. It is also recommended that if the Power Transmitter is to be delivered with an AC adapter, the AC adapter should be Energy Star compliant.

**Table 61. Recommended minimum system efficiency (Baseline Power Profile)**

Test Power Receiver	Load [Ω]	Minimum System Efficiency [%]
TPR#1A	3.5	55
TPR#1B	8.7	65
TPR#1C	10	50
TPR#1D	75	25
TPR#1E	5	55

The system efficiency of the Power Transmitter is measured using Test Power Receiver #1, as defined in *Part 3: Compliance Testing*. Measurement of the Power Transmitter efficiency shall proceed as follows:

1. Position Test Power Receiver #1 on the Interface Surface of the Base Station—as guided by the Test Power Receiver’s alignment aid, if necessary.
2. Calculate the Power Transmitter efficiency  $\eta_{\text{system}}$  as:

$$\eta_{\text{system}} = \frac{P_{\text{OL}}}{P_{\text{in}}}$$

3. Repeat the above 2 steps 3 times, and calculate the average Power Transmitter efficiency  $\eta_{\text{average}}$  as:

$$\eta_{\text{average}} = \frac{1}{3} \sum_{i=1}^3 \eta_{\text{system}}(i)$$



## 8.2.2 Extended Power Profile

Table 62 provides recommendations for the minimum system efficiency for Extended Power Profile devices. Note that this table augments Table 61.

**Table 62. Recommended minimum system efficiency (Extended Power Profile)**

Test Power Receiver	Volume I Power Transmitter (5 W)		Volume II Power Transmitter (15 W)	
	Load [Ω]	Minimum System Efficiency [%]	Load [Ω]	Minimum System Efficiency [%]
TPR#1A	3.5	55	3.5	55
TPR#1B	8.7	65	8.7	65
TPR#1C	10	50	10	50
TPR#1D	75	25	75	25
TPR#1E	5	55	5	55
TPR#MP1A	—	—	4.2	65
TPR#MP1B	—	—	9.6	70
TPR#MP1C	—	—	12	75

## 8.3 Power Receiver efficiency

Measurement of the Power Receiver efficiency shall proceed as follows:

1. **Baseline Power Profile:** Position the Power Receiver (Mobile Device) under test on the Interface Surface of Test Power Transmitter #2 defined in *Part 3: Compliance Testing*—as guided by the Power Receiver’s alignment aid, if necessary.

**Extended Power Profile:** Test Power Transmitter #MP1 is used to determine the efficiency of a Power Receiver that negotiates a Guaranteed Power Value of 15 W in the Power Contract.

2. The power delivered to the load of the Power Receiver must be predetermined or set to a known condition  $P_{OL}$ .
3. Measure the amount of power  $P_{in}$  input of the Test Power Transmitter, at a power dissipation  $P_{OL}$  in the load of the Power Receiver under test.
4. Calculate the system efficiency for the Power Receiver  $\eta_{system}$  as:

$$\eta_{system} = \frac{P_{OL}}{P_{in}}$$

5. Repeat the above 3 steps 3 times, and calculate the average Power Receiver efficiency  $\eta_{average}$  as:

$$\eta_{average} = \frac{1}{3} \sum_{i=1}^3 \eta_{system}(i).$$

## 9 Stand-by Power (Informative)

The purpose of the stand-by mode of operation is to reduce the power consumption of a wireless power transfer system when power transfer is not required. There are two ways to enter stand-by mode. The first is when the Power Transmitter does not detect the presence of a valid Power Receiver. The second is when the Power Receiver transmits only an End Power Transfer Packet. In stand-by mode, the Power Transmitter only monitors if a Power Receiver is placed on or removed from the Interface Surface of the Base Station.

It is recommended that the Base Station's power consumption in stand-by mode of operation meets the Energy Star EPS Requirements for "Energy consumption for No-Load" and the European Commission, Code of Conduct of Energy Efficiency of External Power Supplies for "No-load power consumption." It is also recommended that a Power Receiver is designed in a manner that when wireless power is not required, the Power Receiver will send an End Power Transfer Packet to put the Base Station in stand-by mode.

### 9.1 Transmitter Measurement Method

Measurement of the stand-by power shall proceed as follows:

1. Determine the average power consumption of the input source to the Base Station over 1 hour in the case where there is no Mobile Device present on the Interface Surface of the Base Station.

NOTE The input source may consist of an AC adapter in the case of a mains-operated Base Station or a DC adapter in the case of a battery-operated Base Station, such as in automotive applications.

2. In the case of a Baseline Power Profile Base Station, the next step shall use Test Power Receiver #4. In the case of an Extended Power Profile Base Station, the next step shall use Test Power Receiver #MP2. Both Test Power Receivers are defined in *Part 3: Compliance Testing*.

3. Determine the average power consumption of the input source to the Base Station over 1 hour in the case where the Test Power Receiver is present on the Interface Surface of the Base Station. If the Base Station can serve simultaneous Mobile Devices, multiple Test Power Receivers should be present on the Interface Surface.

NOTE The Test Power Receiver always transmits an End Power Transfer Packet with payload 0x01 (Charge Complete) in response to a Digital Ping (see *Part 3: Compliance Testing*).

## 10 Object Detection (Informative)

A Power Transmitter may use a variety of methods to efficiently discover and locate objects on the Interface Surface. These methods, also known as “analog ping,” do not involve waking up the Power Receiver and starting digital communications. Typically zero or more analog pings precede the Digital Ping, which the Power Transmitter executes in the first *power transfer* phase. This section provides some analog ping examples.

### 10.1 Resonance shift

This analog ping method is based on a shift of the Power Transmitter’s resonance frequency, due to the presence of a (magnetically active) object on the Interface Surface.

For a type A10 Power Transmitter, this method proceeds as follows: The Power Transmitter applies a very short pulse to its Primary Coil, at an Operating Frequency  $f_{od}$ , which corresponds to the resonance frequency of the Primary Coil and series resonant capacitance (in case there is no object present on the Interface Surface). This results in a Primary Coil current  $I_{od}$ . The measured value depends on whether or not an object is present within the Active Area. It is highest if the resonance frequency has not shifted due to the presence of an object. Accordingly, if  $I_{od}$  is below a threshold value  $I_{odt}$ , the Power Transmitter can conclude that an object is present. Note that the values of  $f_{od}$  and  $I_{odt}$  are implementation dependent.

The Power Transmitter can apply the pulses at regular intervals  $t_{odi}$ , where each pulse has a duration of at most  $t_{odd}$   $\mu$ s. Measurement of the Primary Coil current  $I_{od}$  should occur at most  $t_{odm}$   $\mu$ s after the pulse. See also Figure 44 and Table 63.

Figure 44. Analog ping based on a resonance shift

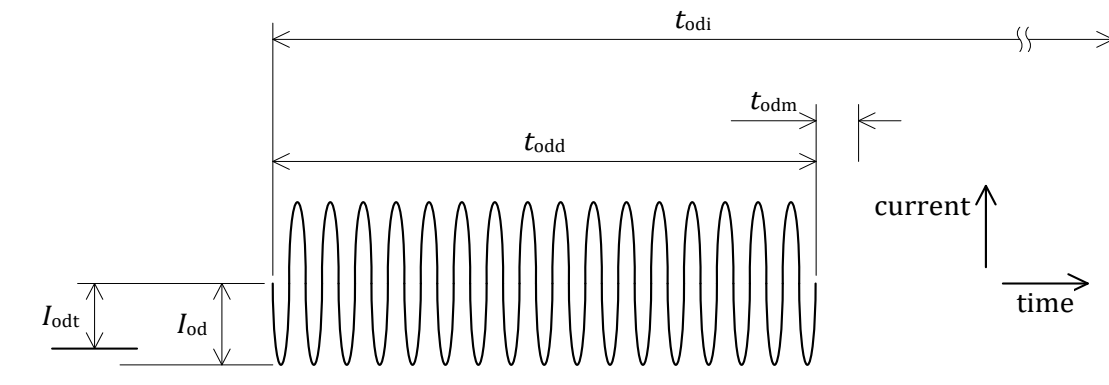

**Table 63. Analog ping based on a resonance shift**

Parameter	Symbol	Value	Unit
Object detection interval	$t_{odi}$	500	ms
Object detection duration	$t_{odd}$	70	$\mu$ s
Object detection measurement	$t_{odm}$	19.5	$\mu$ s

For type B1 and B2 Power Transmitters, this method proceeds as follows: The Power Transmitter applies a very short pulse to a set of Primary Coils, which the multiplexer has connected in parallel. Note that this set is not necessarily limited to a Primary Cell. The Operating Frequency  $f_{od}$  of the pulse corresponds to the resonance frequency of the set of Primary Coils and the capacitance of the impedance matching circuit (in case there is no object present on the Interface Surface). This results in a current  $I_{od}$  through the inductance of the impedance matching circuit. The measured value depends on whether or not an object is present within the Active Area. It is lowest if the resonance frequency has not shifted due to the presence of an object. Accordingly, if  $I_{od}$  is above a threshold value  $I_{odt}$ , the Power Transmitter can conclude that an object is present. Note that the values of  $f_{od}$  and  $I_{odt}$  are implementation dependent.

The Power Transmitter can apply the pulses at regular intervals  $t_{odi}$ , where each pulse has a duration of at most  $t_{odd}$   $\mu$ s. Measurement of the current  $I_{od}$  should occur at most  $t_{odm}$   $\mu$ s after the pulse. See also Figure 44 and Table 63.

## 10.2 Capacitance change

This analog ping method is based on a change of the capacitance of an electrode on or near the Interface Surface, due to the placement of an object on the Interface Surface.

This method is particularly suitable for Power Transmitters that use Free Positioning, because it enables implementations that have a very low stand-by power, and yet exhibit an acceptable response time to a user. The reason is that (continuously) scanning the Interface Surface for changes in the arrangement of objects and Power Receivers thereon is a relatively costly operation. In contrast, sensing changes in the capacitance of an electrode can be very cheap (in terms of power requirements).

NOTE Capacitance sensing can proceed with substantial parts of the Base Station powered down.

Power Transmitters designs that are based on an array of Primary Coils can use the array of Primary Coils as the electrode in question. For that purpose, the multiplexer should connect all (or a relevant subset of) Primary Coils in the array to a capacitance sensing unit—and at the same time disconnect the Primary Coils from the driving circuit. Power Transmitter designs that are based on a moving Primary Coil can use the detection coils on the Interface Surface (see Annex B.3) as electrodes.

It is recommended that the capacitance sensing circuit is able to detect changes with a resolution of 100 fF or better. If the sensed capacitance change exceeds some implementation defined threshold, the Power Transmitter can conclude that an object is placed onto or removed from the Interface Surface. In that case, the Power Transmitter should proceed to localize the objects and attempt to identify the Power Receivers on the Interface Surface, e.g. as discussed in Annex B.

# 11 Foreign Object Detection

## 11.1 Introduction

A Base Station can potentially raise the temperature of a Foreign Object that is positioned on its Interface Surface within or close to the Active Area. Such a temperature rise generally is due to eddy and/or induced currents that the Power Signal generates within the Foreign Object, and depends on the size, shape, material and surrounding properties of the Foreign Object, as well as on the strength and duration of the Power Signal.

A Base Station includes at least one method to limit the temperature rise of Foreign Objects that are positioned on its Interface Surface. Such a method typically involves terminating the power transfer to a Mobile Device if the Base Station determines that a Foreign Object is present, is close to its Active Area, and is being heated by the magnetic field. One method, for example, is to monitor the temperature of the Base Station Interface Surface for the occurrence of hot spots. Another possibility is to monitor the power loss across the interface between the Base Station and Mobile Device, based on the Received Power reported by the Mobile Device and the Base Station's knowledge of its Transmitted Power. Yet another strategy is to actively cool the Base Station Interface Surface, in order to drain away heat from Foreign Objects and—as an added benefit—from the Mobile Device. Other methods or variations on these methods can be applied as well, such as calculating the system efficiency or detecting abnormal behavior at one of the Base Station's parameters.

In order to enable a Power Transmitter to monitor the power loss across the interface as one of the possible methods to limit the temperature rise of Foreign Objects (see Section 4, *Thermal interface*), a Power Receiver shall report its Received Power to the Power Transmitter.

The Received Power  $P_{PR}$  indicates the total amount of power that is dissipated within the Mobile Device due to the magnetic field produced by the Power Transmitter. The Received Power equals the power that is available from the output of the Power Receiver plus any power that is lost in producing that output power. For example, the power loss includes, but is not limited to:

- the power loss in the Secondary Coil and series resonant capacitor,
- the power loss in the Shielding of the Power Receiver,
- the power loss in the rectifier,
- the power loss in any post-regulation stage, and
- the eddy current loss in metal components or contacts within the Power Receiver.

Section 11.2 defines a method that a Power Transmitter may use to prevent heating of Foreign Objects. Section 11.4, *FOD based on calibrated power loss accounting*, extends this method with calibration of the Received Power and Transmitter Power (FOD extensions). This calibration is performed after the Power Transmitter has ensured that no Foreign Objects are present on the Interface Surface. To ensure that the latter is indeed the case, the Power Transmitter may use the method defined in Section 11.3, *FOD based on quality factor change*. This method is based on a measurement of the quality factor of the Primary Coil, which changes in a predictable way if a Power Receiver is positioned on the Interface Surface and no Foreign Objects are nearby.

This version of the Specification does not require a Base Station to implement any particular method. However, in order to comply with this version of the Specification, a Base Station shall limit the temperature rise of any one of the Foreign Objects contained in the set of representative Foreign Objects defined in *Part 3: Compliance Testing* when transferring power to a representative Power Receiver. See *Part 3: Compliance Testing* for more details.

## 11.2 Baseline Power Profile without FOD extensions

This Specification does not define any specific method for a Power Receiver using the Baseline Power Profile to determine the Received Power, but as an example, the Power Receiver could measure the net power provided at its output and add estimates of any applicable power loss.

A Power Receiver shall report its Received Power  $P_{\text{received}}$  in a Received Power Packet (see Section 5.2.3.4, *8-bit Received Power Packet (0x04)*) such that  $P_{\text{received}} - 350 \text{ mW} \leq P_{\text{PR}} \leq P_{\text{received}}$ .

NOTE This means that the reported Received Power is an overestimate of the actual Received Power  $P_{\text{PR}}$  by at most 350 mW. In particular, this implies that the reported Received Power is greater than or equal to the Transmitted Power in the case that there is no Foreign Object present on the Interface Surface. This is because in the latter case, the Received Power equals the Transmitted Power, and as a result, a Power Transmitter is less likely to falsely detect a Foreign Object.

NOTE In view of the accuracy  $\Delta P_{\text{TPT}}$  of the Test Power Transmitter that is used to verify compliance to the above requirement (see *Part 3: Compliance Testing*), it is recommended that a Power Receiver overestimates the actual Received Power  $P_{\text{PR}}$  by at least  $2\Delta P_{\text{TPT}}$ .



## 11.3 FOD based on quality factor change—FOD extensions

The Power Transmitter shall attempt to detect Foreign Objects on its Interface Surface before proceeding to the *power transfer* phase. It may apply different methods for such Foreign Object Detection. One of these methods is based on the detection of a change in the Primary Coil's quality factor.

A change in the environment of the Primary Coil typically causes its inductance to decrease and/or its equivalent series resistance to increase. Both effects lead to a decrease of the Primary Coil's quality factor (*Q*-factor). To enable the Power Transmitter to determine if a measured *Q*-factor decrease is due to the combination of a Power Receiver and a Foreign Object, the Power Receiver shall provide the Power Transmitter with a Reference Quality Factor. This Reference Quality Factor consists of the *Q*-factor that can be measured at the terminals of Test Power Transmitter #MP1's Primary Coil if the Power Receiver is positioned on its Interface Surface and no Foreign Object is nearby.

The method consists of the following four steps:

1. Measure the *Q*-factor of the Primary Coil before power transfer starts. The Power Transmitter should perform this step before it initiates the Digital Ping to wake up the Power Receiver.
2. Send the Reference Quality Factor Value. The Power Receiver shall perform this step as part of the *negotiation* phase. See Section 5.1.3.4.2.3, *FOD Status Packet*.
3. Use the Reference Quality Factor Value to determine an appropriate threshold value. The Power Transmitter should perform this step as part of the *negotiation* phase. See Section 5.1.3.4.2.3. To determine an appropriate threshold value, the Power Transmitter should account for any design differences of its Primary Coil and the Primary Coil of Test Power Transmitter #MP1.
4. Terminate power transfer if the measured *Q*-factor of the Primary Coil is below the threshold. See Section 5.1.3.4.2.3. The Power Transmitter should perform this step as part of the *negotiation* phase.

*Q*-factor measurements performed before power transfer can create voltages in the PRx sufficient to make the rectifier diodes conduct and charge the filter capacitor. The current passing into the filter capacitors can affect the *Q* factor measurements. It is recommended to keep the energy in the Primary Coil low enough to prevent an increase in leakage current in the PRx.

Alternatively, the *Q*-factor measuring methods can employ techniques capable of developing a reverse bias voltage across the rectifier diodes in the PRx. This prevents an increase in leakage current through the rectifier. If such techniques are used, energy developed in the Primary Coil can be higher but not high enough to activate the electronics in the PRx.

### 11.3.1 Q-factor measurement (Informative)

Multiple methods exist to measure the  $Q$ -factor of a coil. Figure 45 describes one of these methods. The left-hand side shows a schematic diagram of the measurement circuit. It consists of a series connection of the coil and a resonance capacitor that is driven by a sinusoidal voltage. The inductance value of the resonance capacitor is chosen such that the resonance frequency of the system is in a suitable range. In this example, the resonance frequency is 100 kHz. The  $Q$ -factor of the coil follows from this system as the ratio of the RMS voltage across the coil and the RMS voltage that is driving the system at the resonance frequency.

Figure 45. Q-factor measurement example

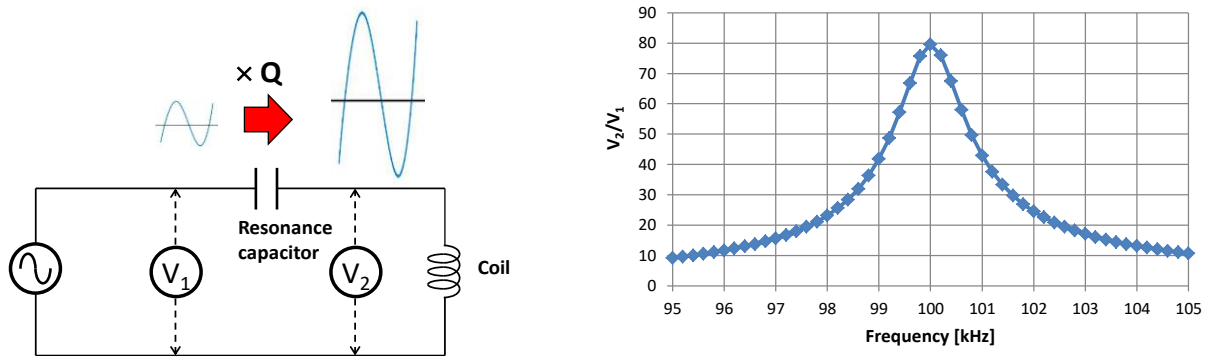

### 11.3.2 Expected operation (Informative)

Directly after the Power Receiver is placed on the Power Transmitter, the Power Transmitter measures the quality factor  $Q_{\text{measured}}$  of its Primary Coil. The Power Transmitter uses a sufficiently small amount of power, such that the Power Receiver does not wake up.

During the *negotiation* phase, the Power Transmitter receives the FOD Status Packet (0x22) and uses the reported Reference Quality Factor Value to determine an appropriate FOD threshold level  $Q_{\text{threshold}}$ . Hereto, the Power Transmitter should account for

- differences between its design and that of Test Power Transmitter #MP1;
- the difference between the frequency it uses to determine its quality factor  $Q_{\text{measured}}$  and 100 kHz;
- the accuracy of its  $Q$ -factor measurement; and
- any manufacturing tolerances.

Accordingly, the resulting threshold level  $Q_{\text{threshold}}$  can be higher or lower than the reported Reference Quality Factor Value. Figure 46 provides an example for a type MP-A1 Power Transmitter design.

**Figure 46. Quality factor threshold example**

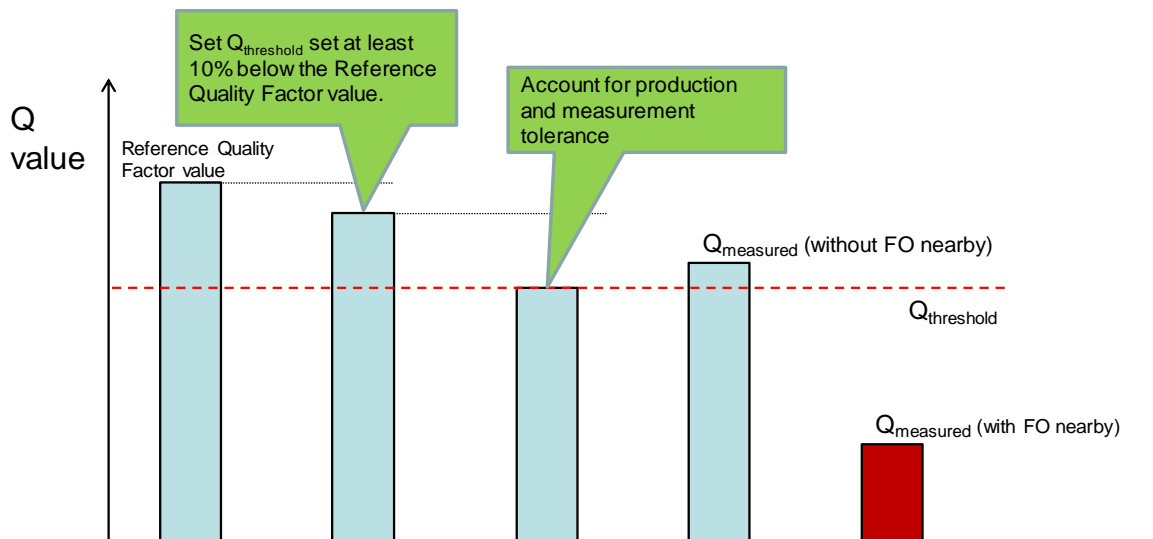

After determining the threshold value  $Q_{\text{threshold}}$  from the Reference Quality Factor Value, the Power Transmitter can decide whether a Foreign Object is present or not. In particular, the Power Transmitter responds to the FOD Status Packet (0x22) as follows:

- Provide an ACK Response if  $Q_{\text{measured}} \geq Q_{\text{threshold}}$ . A Foreign Object is most likely not present on the Interface Surface.
- Provide a NAK Response if  $Q_{\text{measured}} < Q_{\text{threshold}}$ . A Foreign Object is likely to be present on the Interface Surface.

### 11.3.3 Definition of the Reference Quality Factor

The Reference Quality Factor of a Power Receiver is defined as the  $Q$ -factor of Test Power Transmitter #MP1's Primary Coil at an operating frequency of 100 kHz with the Power Receiver positioned on the Interface Surface and no Foreign Object nearby. The positioning of the Power Receiver on the Interface Surface shall be as follows.

- Align the Secondary Coil of the Power Receiver with the Primary Coil of Test Power Transmitter #MP1 (i.e. the center position).
- Move the Power Receiver without rotating it to an offset position of  $\pm 5$  mm along the X and Y axes.

NOTE Test Power Transmitter #MP1 defines the direction of the X and Y axes.

- Determine the Reference Quality Factor at the center position and in each of the four offset positions, and select the lowest value.

NOTE It is recommended to measure the Reference Quality Factor with a Primary Coil voltage of  $(0.85 \pm 0.25)$  V rms.

The Reference Quality Factor value as reported in a FOD Status Packet (see Section 5.2.3.14) shall have an accuracy of  $\pm 10\%$  or better.

## 11.4 FOD based on calibrated power loss accounting—FOD extensions

The Power Transmitter may apply different methods for Foreign Object Detection during the *power transfer* phase. One of these methods is the power loss method.

### 11.4.1 Introduction

The power loss  $P_{\text{loss}}$ , which is defined as the difference between the Transmitted Power  $P_{\text{PT}}$  and the Received Power  $P_{\text{PR}}$ , i.e.  $P_{\text{loss}} = P_{\text{PT}} - P_{\text{PR}}$ , provides the power absorption in Foreign Objects:

- The Transmitted Power  $P_{\text{PT}}$  represents the amount of power that leaves the Base Station due to the magnetic field of the Power Transmitter
- The Received Power  $P_{\text{PR}}$  represents the amount of power that is dissipated within the Mobile Device due to the magnetic field of the Power Transmitter
- The power loss  $P_{\text{loss}}$  in Foreign Objects represents the amount of power dissipated from the magnetic field of the Power Transmitter in objects that are neither part of the Base Station nor of the Mobile Device.

The Power Transmitter can determine its Transmitted Power  $P_{\text{PT}}$  by measuring the power  $P_{\text{in}}$  provided at its input and subtracting any power  $P_{\text{PTloss}}$  that is dissipated inside the Base Station. This power  $P_{\text{PTloss}}$  includes, for example:

- the power loss in the inverter,
- the power loss in the Primary Coil,
- the power loss in resonance capacitors,
- the power loss in the Shielding of the Primary Coil assembly, and
- the power loss in any metal parts of the Base Station.

The Power Receiver can determine its Received Power  $P_{PR}$  by measuring the power  $P_{out}$  provided at its output and adding any power  $P_{PRLoss}$  that is lost inside the Mobile Device. This power  $P_{PRLoss}$  includes, for example:

- the power loss in the rectifier,
- the power loss in the Secondary Coil,
- the power loss in the resonance capacitor,
- the power loss in the Shielding of the Secondary Coil assembly, and
- the power loss in any metal parts of the Mobile Device.

Figure 47 illustrates the above.

**Figure 47. Power losses illustrated**

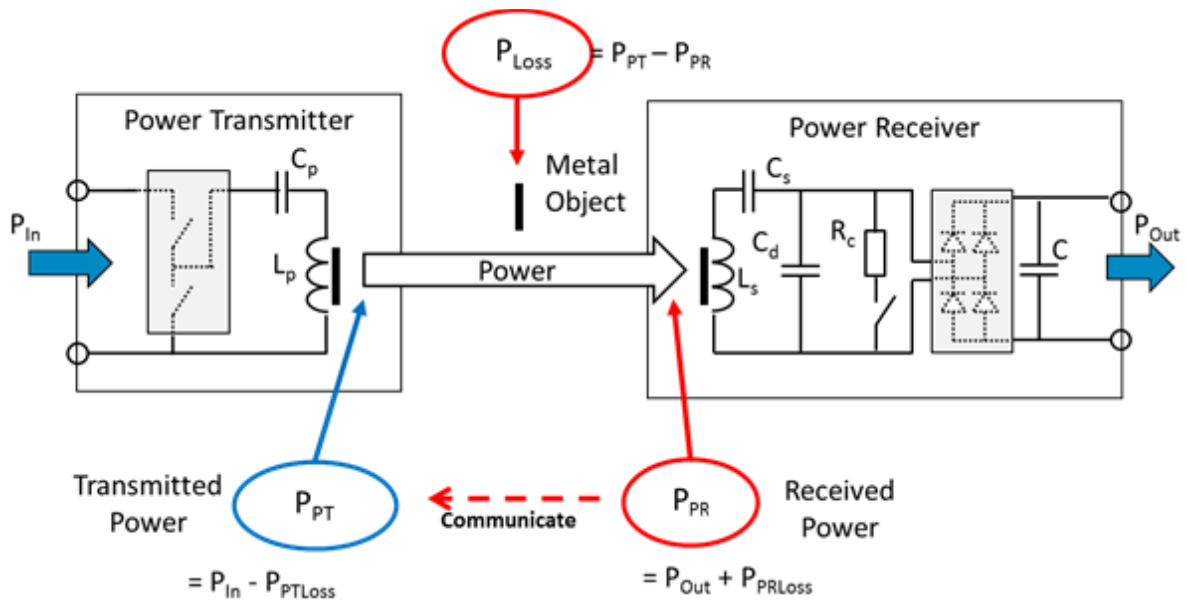

After receiving a Received Power Packet, the Power Transmitter can calculate the power loss and compare it to a threshold. If the power loss exceeds this threshold for one or more consecutive Received Power Packets, the Power Transmitter can conclude that a Foreign Object is present on its Interface Surface. To limit heating of the Foreign Object in that case, the Power Transmitter should remove the Power Signal, which terminates the transfer of power to the Power Receiver. Experiments have shown that 300 mW is an appropriate threshold value for limiting heating of Foreign Objects.

The Power Receiver determines its Received Power as the average power that it dissipates from the magnetic field in a time window that precedes its transmission of the Received Power Packet. The properties of this time window are defined in the Configuration Packet. See Section 5.2.3.7, *Configuration Packet (0x51)*, Section 5.2.3.4, *8-bit Received Power Packet (0x04)*, and Section 5.2.3.11, *24-bit Received Power Packet—FOD extensions only (0x31)*. The Power Transmitter should determine its Transmitted Power as the average power that leaves the Base Station in the same time window. Without this synchronization, the calculated power loss may spuriously exceed the threshold, e.g. if the Power Receiver has changed its power consumption between its measurement of the Received Power and the Power Transmitter’s measurement of the Transmitted power.

### 11.4.2 Received Power accuracy

The effectiveness of the power loss method depends on the accuracy with which the Power Transmitter and the Power Receiver can determine their Transmitted Power and Received Power.

A Power Receiver shall determine its Received Power  $P_{PR}$  with an accuracy of  $\pm P_{\Delta}$ , and shall report its Received Power as  $P_{received} = P_{PR} + P_{\Delta}$ . This means that the reported Received Power is always greater than or equal to the Transmitted Power  $P_{PT}$  if there is no Foreign Object present on the Interface Surface.

NOTE Using this approach, the Power Transmitter is less likely to falsely detect a Foreign Object than if the Power Receiver were allowed to underestimate its Received Power.

As defined in Table 64, the maximum value of the Received Power accuracy  $P_{\Delta}$  depends on the Maximum Power of the Power Receiver. This accuracy applies throughout the *power transfer* phase, regardless of the instantaneous output power. For example, if the Maximum Power of the Power Receiver is 10 W and its instantaneous output power is 4 W, the maximum value of  $P_{\Delta}$  is 500 mW.

**Table 64. Maximum  $P_{\Delta}$**

Maximum Power [W]*	Maximum $P_{\Delta}$ [mW]
0...5	350
5...10	500
10...15	750
* The lower limit is not included in the range.	

### 11.4.3 Calibration

Typically, a Power Receiver estimates the power loss inside the Mobile Device in order to determine its Received Power. Similarly, the Power Transmitter estimates the power loss inside the Base Station to determine its Transmitted Power. A systematic bias in these estimates results in a difference between the Transmitted power and the Received Power, even if there is no Foreign Object present on the Interface Surface. Such a bias deteriorates the effectiveness of the power loss method for Foreign Object Detection, because it effectively reduces the detection threshold: if the Power Transmitter uses a higher threshold to compensate for this bias, the probability that it does not detect Foreign Objects increases. Conversely, if the Power Transmitter does not use a higher threshold, the probability for falsely detecting a Foreign Object increases.

To increase the effectiveness of the power loss method, the Power Transmitter can remove the bias in the calculated power loss by calibration. For this purpose, the Power Transmitter and Power Receiver execute the *calibration* phase before the *power transfer* phase starts (see Section 5, *Information interface*, for details). A precondition for successful calibration is that the Power Transmitter has verified that there is no Foreign Object present on its Interface Surface. For this purpose, the Power Transmitter can use the method defined in Section 11.3, *FOD based on quality factor change*.

Since the bias in the estimates can be dependent on the power level, the calibration should ideally be carried out at many power levels between the lowest power and the power that the Power Receiver expects to provide at its output. Since this is impractical, there is a compromise: in the *calibration* phase, the Power Transmitter and Power Receiver determine their Transmitted Power and Received Power at two load conditions—a “light” load and a “connected” load.

The “light” load is close to the minimum expected output power, and the “connected” load is close the maximum expected output power. Based on these two load conditions, the Power Transmitter can calibrate its Transmitted Power using linear interpolation (see Section 11.4.3.1, *Calibrated Transmitted Power*). Alternatively, the Power Transmitter can calibrate the reported Received Power (see Section 11.4.3.2, *Calibrated Received Power*).

For the “light” load condition, the Power Receiver shall limit its Received Power to at most 10% of its Maximum Power. Moreover, it shall comply with the provisions of Section 11.3.2 for the accuracy of reporting this Received Power.

**NOTE** For example, if the Maximum Power Value in the Configuration Packet is 30, the Received Power in the “light” load condition is at most 1.5 W. The required accuracy  $\pm P_{\Delta}$  of the reported Received Power is in this case 750 mW or better (see Table 64). For reporting its Received Power to the Power Transmitter, the Power Receiver adds this accuracy to its measured value. For example, if the Power Receiver measures a Received Power of 1.5 W, with an accuracy of 750 mW, it reports a Received Power of 2.25 W.



### 11.4.3.1 Calibrated Transmitted Power

If the Power Transmitter calibrates its Transmitted Power, it is recommended that it does so using linear interpolation,

$$P_{\text{calibrated}} = a \cdot P_{\text{transmitted}} + b.$$

Here,  $P_{\text{transmitted}}$  is the Transmitted Power that the Power Transmitter estimates;  $P_{\text{calibrated}}$  is the calibrated Transmitted Power, and  $a$  and  $b$  are calibration constants. To determine the calibration constants, the Power Transmitter uses its Transmitted Power  $P_{\text{transmitted}}^{(\text{light})}$  and  $P_{\text{transmitted}}^{(\text{connected})}$ , which it estimates in the “light” load and “connected” load conditions. In addition, the Power Transmitter uses the Received Power  $P_{\text{received}}^{(\text{light})}$  and  $P_{\text{received}}^{(\text{connected})}$  that it receives from the Power Receiver as the target  $P_{\text{calibrated}}^{(\text{light})}$  and  $P_{\text{calibrated}}^{(\text{connected})}$  values respectively. Solving the two equations for the calibration constants yields

$$a = \frac{P_{\text{received}}^{(\text{connected})} - P_{\text{received}}^{(\text{light})}}{P_{\text{transmitted}}^{(\text{connected})} - P_{\text{transmitted}}^{(\text{light})}}$$

$$b = \frac{P_{\text{transmitted}}^{(\text{connected})} \cdot P_{\text{received}}^{(\text{light})} - P_{\text{received}}^{(\text{connected})} \cdot P_{\text{transmitted}}^{(\text{light})}}{P_{\text{transmitted}}^{(\text{connected})} - P_{\text{transmitted}}^{(\text{light})}}$$

Subsequently, the Power Transmitter should use the calibrated Transmitted Power to determine the power loss as follows:

$$P_{\text{loss}} = P_{\text{calibrated}} - P_{\text{received}}.$$

### 11.4.3.2 Calibrated Received Power

If the Power Transmitter calibrates the reported Received Power, it is recommended that it does so using linear interpolation:

$$P_{\text{calibrated}} = a \cdot P_{\text{received}} + b.$$

Here,  $P_{\text{received}}$  is the Received Power that the Power Receiver reports;  $P_{\text{calibrated}}$  is the calibrated Received Power, and  $a$  and  $b$  are calibration constants. To determine the calibration constants, the Power Transmitter uses the Received Power  $P_{\text{received}}^{(\text{light})}$  and  $P_{\text{received}}^{(\text{connected})}$  that it obtains from the Power Receiver in the “light” load and “connected” load conditions. In addition, the Power Transmitter uses its Transmitted Power  $P_{\text{PT}}^{(\text{light})}$  and  $P_{\text{PT}}^{(\text{connected})}$  as the target  $P_{\text{calibrated}}^{(\text{light})}$  and  $P_{\text{calibrated}}^{(\text{connected})}$  values respectively. Solving the two equations for the calibration constants yields

$$a = \frac{P_{\text{PT}}^{(\text{connected})} - P_{\text{PT}}^{(\text{light})}}{P_{\text{received}}^{(\text{connected})} - P_{\text{received}}^{(\text{light})}}$$

$$b = \frac{P_{\text{received}}^{(\text{connected})} \cdot P_{\text{PT}}^{(\text{light})} - P_{\text{PT}}^{(\text{connected})} \cdot P_{\text{received}}^{(\text{light})}}{P_{\text{received}}^{(\text{connected})} - P_{\text{received}}^{(\text{light})}}$$

Subsequently, the Power Transmitter should use the calibrated Received Power to determine the power loss as follows:

$$P_{\text{loss}} = P_{\text{PT}} - P_{\text{calibrated}}.$$

## 11.5 FOD by Power Receiver (Informative)

During power transfer, a Power Receiver can attempt to detect whether a Foreign Object starts to absorb power from the magnetic field by detecting a change in its Received Power  $P_{PR}$ . Such a change can result from:

- a change of the Operating Point of the Power Transmitter;
- a change of the position of the Power Receiver on the Interface Surface;
- a change of the gap between the Power Receiver and the Power Transmitter;
- placement of a Foreign Object; or
- a change of the Power Receiver's load.

By monitoring its output power, the Power Receiver can distinguish between a change in its load and the other possible causes for a change in its Received Power. Moreover, since a Power Transmitter typically only changes its Operating Point directly after receiving a Control Error Packet (see Section 5.2.3.3), the Power Receiver can correlate a change in its Received Power to the placement of a Foreign Object. To make this correlation, the Power Receiver has to assume that its position on the Interface Surface does not change.

It is recommended that the Power Receiver measures its Received Power in the periods between Control Error Packets where the Power Transmitter is supposed to keep its Operating Point constant, see Figure 48. In addition, it is recommended that if the difference between two consecutive measurements exceeds a threshold—which typically is in the range of 250 mW to 750 mW—the Power Receiver takes appropriate action. Examples of such actions include the following:

- Informing the user that a Foreign Object may suddenly have appeared on the Interface Surface.
- Informing the Power Transmitter that a Foreign Object may suddenly have appeared on the Interface Surface, e.g. by sending an End Power Transfer Packet with End Power Transfer Code= 0x0B. This Packet should cause the Power Transmitter to terminate and subsequently restart the power transfer. Prior to such restarts, the Power Transmitter should attempt to detect the presence of a Foreign Object, e.g. using the method defined in Section 11.3, *FOD based on quality factor change*.

Figure 48. Computation of  $\Delta P_{received}$

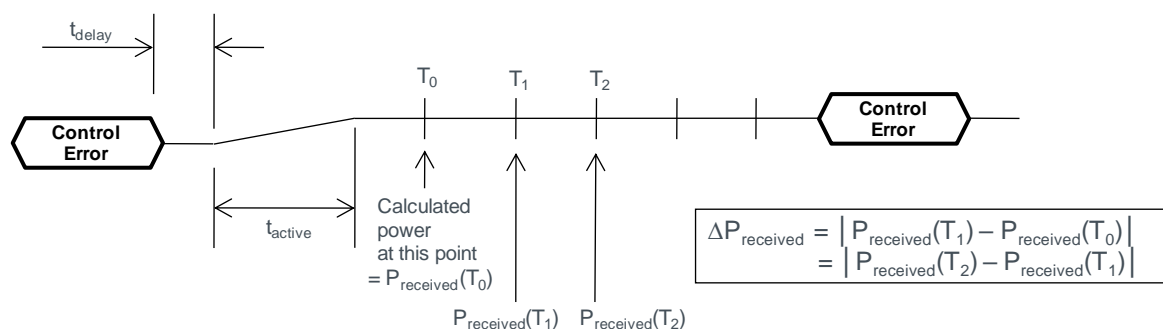

## 12 Unintentional Magnetic Field Susceptibility (Informative)

### 12.1 Limits

It should also be noted that a Power Receiver can be exposed to higher than expected fields during otherwise normal operation. For example, if the Power Receiver is suddenly moved such that its coupling with the Power Transmitter changes significantly, the communications channel can become unusable and the voltage generated across the Secondary Coil can increase unexpectedly.

### 12.2 Protection

In the case that the output disconnect switch is open, it is recommended that a Power Receiver can withstand a voltage generated across its Secondary Coil of at least  $U_{ovp}$ . Here,  $U_{ovp}$  is the larger of

- 1.6 times the maximum target rectified voltage as defined in Table 65, or
- the voltage that results if coupled with a type MP-A1 Power Transmitter that is operating at its minimum Operating Frequency and maximum phase difference between the legs of its full-bridge inverter.

**Table 65. Examples of the recommended  $U_{ovp}$**

Maximum Target Rectified Voltage [V]	Recommended $U_{ovp}$ [V]
12	20
20	32
30	48

### 12.3 Power Transmitter detection

To detect whether the Power Signal originates from a Power Transmitter, as described in Section 5.2.1, the Power Receiver should also take into account the Power Transmitter designs defined in *Part 4: Reference Designs*.

## 13 User Interface

A user will typically interface with both a Base Station and a Mobile Device. The goal is to provide clear feedback<sup>14</sup> to a user.

### 13.1 User interaction with a Base Station

A Base Station shall indicate the following conditions to a user:

- Indication to a user within 0.5 seconds that a Mobile Device or object is placed on the Base Station.
- Indication to a user whether power transfer or charging is in progress or not.
- Indication to a user whether power transfer or charging is complete.
- Indication to a user in case of an error of fault (in stand-by, at the initiation of, during or at the completion of power transfer or charging).
- (Extended Power Profile only) Whether power transfer or charging occurs at a reduced rate.

NOTE A Power Transmitter should indicate this condition if it has denied a Specific Request for Guaranteed Power (Request = 0x01).

A Base Station should indicate the following condition to a user:

- Indication to a user if a Foreign Object has been detected.

A Base Station that is able to support multiple Mobile Devices at the same time shall indicate each of the above conditions for each supported Mobile Device.

A Base Station that can take input power from a USB Micro-B or Micro-AB receptacle shall indicate to the user if the requested amount of power potentially cannot be provided to a Mobile Device. In particular, this indication

- should be activated prior to the start of power transfer to a Mobile Device, preferably when the Base Station is switched on;
- shall be activated during power transfer to a Mobile Device, if the Base Station cannot provide the requested amount of power; and
- once activated, should remain active until the Base Station leaves the *power transfer* phase.

---

<sup>14</sup> Audible, visible, or tactile indication

## 13.2 User interaction with a Mobile Device

A Mobile Device should indicate the following conditions to users:

- Successful reception of the Power Signal within 3 seconds after being placed on a Base Station.
- End of reception of the Power Signal.

**(FOD extensions supported)** A Power Receiver that can negotiate a Guaranteed Power value in the Power Transfer Contract that is greater than 5 W shall indicate the status of the power transfer as declined, reduced, or full, where

- *declined* means that the Power Transmitter cannot provide the minimum power level that is necessary for operation of the Power Receiver; power transfer therefore does not proceed;
- *reduced* means that the Power Transmitter cannot provide the amount of power that is necessary for optimal operation of the Power Receiver; power transfer therefore continues at a reduced rate; and
- *full* means that the Power Transmitter can provide the amount of power that is necessary for optimal operation of the Power Receiver; power transfer therefore continues at the full rate or at the optimal rate.

## Annex A EMC Standards and Regulations (informative)

### A.1 EMC

#### A.1.1 Regulatory obligation

Base Stations and Mobile Devices as defined in this Specification can emit and/or can be sensitive to Electro Magnetic (EM) fields. In most countries, regulations with respect to Electro Magnetic Compatibility (EMC) are in place.

As these regulations comprise legal requirements, a Base Station or Mobile Device shall comply with all regulations for the countries where that Base Station or Mobile Device is sold.

#### A.1.2 Product category

The standards on which regulations are based can depend on the product category. Requirements for emissions and immunity can vary accordingly. These product categories include:

- Information technology
- Lighting
- Healthcare
- Automotive
- Household appliance

A Mobile Device shall comply with the applicable standards for the product category that fits the function of the Mobile Device (for example, a phone or digital music player).

A Base Station can be seen as a universal inductive charger and will most likely be used in a household environment. The applicable product category is therefore the category of household appliances.

#### A.1.3 Applicable standards

Most EMC regulations for household appliances are based on the standards are listed in Table 66. These standards regulate the allowed emissions of EM fields and require minimum immunity to EM fields. For products that are intended for specific applications or environments (e.g. for medical applications or in car environment), different standards can apply.

**Table 66. Applicable EMC standards for household appliances**

Region	Regulation or Standard*
World	CISPR 14-1, CISPR 14-2
United States	FCC 47 CFR part 15
Europe	EMC directive/EN 55014-1, EN 55014-2

\* The standards in this table specify minimum immunity levels. In order to guarantee full functionality, higher immunity levels could be needed.

## A.2 User Exposure to Magnetic Fields (informative)

### A.2.1 Introduction

Power Transmitters emit electro-magnetic (EM) fields.

International exposure guidelines recommend limits for human EM exposure. Typically, the EMF regulations in different countries are based on these limits. The limits are based on the scientific work by independent organizations such as ICNIRP and IEEE. All products that comply with this version of the Specification are subject to these local regulations. Manufacturers are responsible for compliance with these regulations in all relevant countries.

This section refers to applicable standards and quotes the applicable measurement methods and limits. Some recommendations are given as well.

### A.2.2 Applicable standards

IEC62311 *“Assessment of electronic and electrical equipment related to human exposure restrictions for electromagnetic fields (0Hz -300GHz).”*

This is the generic standard limiting the emission of magnetic and electric fields from all types of electric and electronic products. This general standard is applicable in case a product standard is not applicable.

IEC62233 *“Measurement methods for electromagnetic fields of household appliances and similar apparatus with regards to human exposure.”*

This is the standard limiting the emission of magnetic and electric fields for household appliances and similar apparatus. The measurement methods specified in this standard are valid for magnetic field from 10 Hz to 400 kHz. A Power Transmitter in combination with a Power Receiver will usually qualify as household appliance. Examples of exceptions are medical and in-car applications. For a full list of exceptions refer to IEC62233.



## A.2.3 Measurement method

### A.2.3.1 Magnetic field sensor

Measurement values of magnetic flux density are averaged over an area of 100 cm<sup>2</sup> in each direction. The reference sensor consists of 3 mutually-perpendicular coils (see Figure 49) with a measuring area of 100±5 cm<sup>2</sup> to provide isotropic sensitivity.

Figure 49. Magnetic field sensor

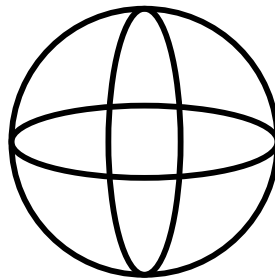

### A.2.3.2 Measuring distance

If the intended use of the appliance is contact with the human body, the measuring distance shall be 0 cm, excluding the extent of the measurement sensor. For all other appliances, the measurement distance shall be 30 cm.

## A.2.4 Limits (reference levels)

The guidance in EMF exposure standards is given in terms of basic restrictions and reference levels. The basic restrictions on EMF exposure are based directly on established health effects, and compliance with the guidelines requires that the basic restrictions are not violated. Reference levels (also known as maximum permissible exposure values or investigation levels) are provided for practical exposure assessment purposes to determine whether the basic restrictions are likely to be exceeded. If the reference levels are met, then the basic restrictions will also be met; if the reference levels are exceeded, that does not necessarily mean that the basic restrictions are exceeded. In some situations, it may be possible to show compliance with the basic restrictions directly. It may also be possible to derive compliance criteria that allow a simple measurement or calculation to demonstrate compliance with the basic restriction. Often these compliance criteria can be derived using realistic assumptions about conditions under which exposures from a device may occur, rather than the conservative assumptions that are the basis for the reference levels.

### A.2.4.1 Compliance criteria

Depending on the region where the product will be put on the market, the basic restrictions for general public of either IEEE C95.1 2005 or ICNIRP 1998 are applicable. The limits given below are only for information and are not an exhaustive list. It is the responsibility of users of this standard to ensure that they use the current version of the limit sets as specified by national authorities.

### A.2.4.2 Applicable limits

#### A.2.4.2.1 ICNIRP 1998

**Table 67. Basic restrictions (BR) for general public exposure to time varying electric and magnetic fields for frequencies up to 10 GHz**

Frequency range	Current density (head and trunk) mA/m <sup>2</sup> (rms)	Average SAR (whole body) W/kg	Localised SAR (head and trunk) W/kg	Localised SAR (limbs) W/kg
Up to 1 Hz	8			
1 Hz – 4 Hz	$8/f$			
4 Hz – 1000 Hz	2			
1 kHz – 100 kHz	$f/500$			
100 kHz – 10 MHz	$f/500$	0.08	2	4
10 MHz – 10 GHz		0.08	2	4

NOTE  $f$  is the frequency in Hertz.

**Table 68. Reference levels for general public exposure to time varying electric and magnetic fields**

Frequency range	E-field strength (V m <sup>-1</sup> )	H-field strength (A m <sup>-1</sup> )	B-field (μT)
Up to 1 Hz	—	$3.2 \times 10^4$	$4 \times 10^4$
1 – 8 Hz	10,000	$3.2 \times 10^4/f^2$	$4 \times 10^4/f^2$
8 – 25 Hz	10,000	$4,000/f$	$5,000/f$
0.025 – 0.8 kHz	$250/f$	$4/f$	$5/f$
0.8 – 3 kHz	$250/f$	5	6.25
3 – 150 kHz	87	5	6.25
0.15 – 1 MHz	87	$0.73/f$	$0.92/f$

NOTE  $f$  as indicated in the frequency range column.

#### A.2.4.2.2 ICNIRP 2010

**Table 69. Reference levels for general public exposure to time-varying electric and magnetic fields (unperturbed RMS values)**

Frequency range	E-field strength E (kV m <sup>-1</sup> )	Magnetic field strength H (A m <sup>-1</sup> )	Magnetic flux density B (T)
1 Hz – 8 Hz	5	$3.2 \times 10^4 / f^2$	$4 \times 10^{-2} / f^2$
8 Hz – 25 Hz	5	$4 \times 10^3 / f$	$5 \times 10^{-3} / f$
25 Hz – 50 Hz	5	$1.6 \times 10^2$	$2 \times 10^{-4}$
50 Hz – 400 Hz	$2.5 \times 10^2 / f$	$1.6 \times 10^2$	$2 \times 10^{-4}$
400 Hz – 3kHz	$2.5 \times 10^2 / f$	$6.4 \times 10^4 / f$	$8 \times 10^{-2} / f$
3 kHz – 10 MHz	$8.3 \times 10^{-2}$	21	$2.7 \times 10^{-5}$

NOTES

- f in Hz.
- See separate sections below for advice on non-sinusoidal and multiple frequency exposure.
- In the frequency range above 100 kHz, RF specific reference levels need to be considered additionally.

#### A.2.4.2.3 IEEE

**Table 70. Basic Restrictions applying to various parts of the body for frequencies 3 kHz – 5 MHz and 100 kHz – 3 GHz**

		Action level <sup>a</sup>	Persons in controlled environments
Exposed tissue	$f_e$ (Hz)	$E_0$ (rms) (V/m)	$E_0$ (rms) (V/m)
Brain	20	$5,89 \times 10^{-3}$	$1,77 \times 10^{-2}$
Heart	167	0,943	0,943
Extremities	3350	2,10	2,10
Other tissues	3350	0,701	2,10

a. Within this frequency range the term "action level" is equivalent to the term "general public" in IEEE Std C95.6-2002.  
 $E_0$  is the rheobase in situ field.  $f_e$  is the frequency parameter.

NOTE Entries in Table 2 and elsewhere in this standard are sometimes given to three significant digits. This degree of precision is provided so that the reader can follow the various derivations and relationships presented in this standard, and does not imply that the numerical quantities are known to that precision

**Table 71. Basic Restrictions for frequencies between 100 kHz and 3 GHz**

		Action level <sup>a</sup> SAR <sup>b</sup> (W/kg)	Persons in controlled environments SAR <sup>c</sup> (W/kg)
Whole-body exposure	Whole-Body Average (WBA)	0.08	0.4
Localized exposure	Localized (peak spatial-average)	2 <sup>c</sup>	10 <sup>c</sup>
Localized exposure	Extremities <sup>d</sup> and pinnae	4 <sup>c</sup>	20 <sup>c</sup>
<sup>a</sup> BR for the general public when an RF safety program is unavailable.			
<sup>b</sup> SAR is averaged over the appropriate averaging times as shown in Table 8 and Table 9.			
<sup>c</sup> Averaged over any 10 g of tissue (defined as a tissue volume in the shape of a cube).*			
<sup>d</sup> The extremities are the arms and legs distal from the elbows and knees, respectively.			

\*The volume of the cube is approximately 10 cm<sup>3</sup>.

**Table 72. Maximum permissible exposure levels IEEE for exposure of head and torso, 3 kHz to 5 MHz**

Frequency range (kHz)	Action level <sup>a</sup>		Persons in controlled environments	
	B <sub>rms</sub> (mT)	H <sub>rms</sub> (A/m)	B <sub>rms</sub> (mT)	H <sub>rms</sub> (A/m)
3.0–3.35	0.687/ <i>f</i>	547/ <i>f</i>	2.06/ <i>f</i>	1640/ <i>f</i>
3.35–5000	0.205	163	0.615	490
NOTE— <i>f</i> is expressed in kHz.				
<sup>a</sup> Within this frequency range the term “action level” is equivalent to the term “general public” in IEEE Std C95.6-2002.				

NOTE—The MPEs in Table 2 minimize adverse effects associated with electrostimulation; Tables 8 and 9 apply to effects associated with tissue heating. All three tables must be considered and the corresponding values for the appropriate tier satisfied at all applicable frequencies.

**Table 73. Maximum permissible exposure levels IEEE for exposure of head limbs, 3 kHz to 5 MHz**

Frequency range (kHz)	Action level <sup>a</sup>		Persons in controlled environments	
	$B_{rms}$ (mT)	$H_{rms}$ (A/m)	$B_{rms}$ (mT)	$H_{rms}$ (A/m)
3.0–3.35	$3.79/f$	$3016/f$	$3.79/f$	$3016/f$
3.35–5000	1.13	900	1.13	900
NOTE— $f$ is expressed in kHz.				
<sup>a</sup> Within this frequency range the term “action level” is equivalent to the term “general public” in IEEE Std C95.6-2002.				

### A.2.5 Intended use

- Power Transmitters and Power Receivers should state their intended use at least in the user manual of the product.
- Power Transmitters and Power Receivers that involve touching body parts as intended use may require additional measures to reduce the magnetic field emissions.

### A.2.6 Application notes

- A Power Transmitter should avoid power transfer unless coupling is achieved with an identified Power Receiver.
- Small Power Receivers should be optimized to reduce the Primary Cell current during power transfer as much as possible.

## Annex B Power Receiver Localization (Informative)

This Annex B discusses several aspects that relate to the discovery of Power Receivers amongst the objects that the Power Transmitter has discovered on its Interface Surface.

### B.1 Guided Positioning

In the case of Guided Positioning, discovery and localization of a Power Receiver is straightforward: The Power Transmitter should simply execute a Digital Ping, as defined in Section 5.1.2.2. If the Power Transmitter receives a Signal Strength Packet or an End Power Transfer Packet, it has discovered and located a Power Receiver. Otherwise, the object is not a Power Receiver.

### B.2 Primary Coil array based Free Positioning

In the case of Free Positioning, discovery and localization of a Power Receiver is less straightforward. This Annex B.2 discusses one sample approach, which is particularly suited to a Primary Coil array-based Power Transmitter. In this approach, the Power Transmitter first discovers and locates the objects that are present on its Interface Surface (e.g. using any of the methods discussed in Section 10, *Object Detection (Informative)*). This results in a set of Primary Cells, which represents the locations of potential Power Receivers. For each of the Primary Cells in this set, the Power Transmitter executes a Digital Ping (see Section 5.1.2.2), removing the Power Signal after receipt of a Signal Strength Packet (or an End Power Transfer Packet, or after a time out).<sup>15</sup> This yields a new set of Primary Cells, namely those that report a Signal Strength Value above a certain threshold—which the Power Transmitter chooses. Finally, the Power Transmitter executes an extended Digital Ping (see Sections 5.1.2.2 and 5.1.2.3) for each of the Primary Cells in this new set in order to identify the discovered Power Receivers. The Power Transmitter should take the situations discussed in Annex B.2.1, B.2.2, and B.2.3 into account in order to select the most appropriate Primary Cells from the set for power transfer.

#### B.2.1 A single Power Receiver covering multiple Primary Cells

Figure 50 shows a situation in which the final set contains 12 Primary Cells. In order to select the most appropriate Primary Cell from this set, the Power Transmitter compares all Basic Device Identifiers that it has obtained. In this case, they are all identical. Accordingly, the Power Transmitter concludes that all Primary Cells in the set correspond to one and the same Power Receiver. Therefore, the Power Transmitter selects the Primary Cell that has the highest Signal Strength Value as the most appropriate

---

<sup>15</sup> NOTE The Power Transmitter should ensure that after terminating a Digital Ping using a particular Primary Cell, it waits sufficiently long—for example  $t_{\text{reset}}$  (see Table 15 in Section 5.1.3, *Power Receiver (PRx)* perspective)—prior to executing a Digital Ping to that same Primary Cell or any of its neighboring Primary Cells. This ensures that any Power Receiver that is present on the Interface Surface at the location of the Primary Cell can return to a well-defined state.

Primary Cell to use for power transfer. In the specific example shown in Figure 50, this could be Primary Cell 2, 3, 4, 5, 8, 9, 10, or 11.

**Figure 50. Single Power Receiver covering multiple Primary Cells**

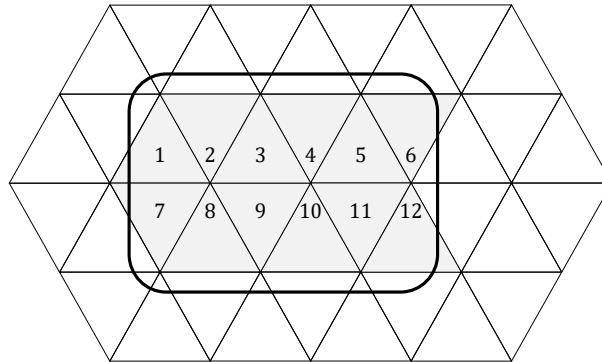

### B.2.2 Two Power Receivers covering two adjacent Primary Cells

Figure 51 shows a situation in which the final set contains 12 Primary Cells—the same set as in the situation discussed in Annex B.2.1. In order to select the most appropriate Primary Cell from this set, the Power Transmitter compares all Basic Device Identifiers that it has obtained. In this case, the Power Transmitter determines that there are two subsets of identical Basic Device Identifiers. Accordingly, the Power Transmitter concludes that it is dealing with two distinct Power Receivers. Therefore, the Power Transmitter selects the most appropriate Primary Cell from each subset. In the specific example shown in Figure 51, this could be Primary Cell 2, or 8 for the left-hand Power Receiver, and Primary Cell 5, or 11 for the right-hand Power Receiver. Note that due to interference, the Power Transmitter most likely cannot communicate reliably using Primary Cells 3, 4, 9, and 10.

**Figure 51. Two Power Receivers covering two adjacent Primary Cells**

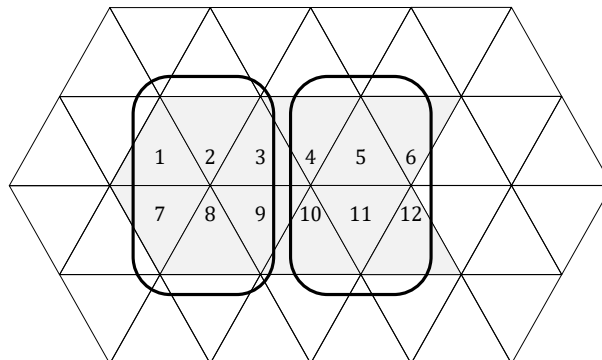

### B.2.3 Two Power Receivers covering a single Primary Cell

Figure 52 shows a situation in which the final set contains 2 Primary Cells. Here, the underlying assumption is that the two Power Receivers have widely different response times ( $t_{\text{wake}}$ , see Section 5.1.3.1, *Selection phase (PRx perspective)*) to a Digital Ping. For example, the left-hand Power Receiver responds very fast (close to  $t_{\text{wake}}^{(\text{early})}$ ), whereas the right-hand Power Receiver responds very slow (close to  $t_{\text{wake}}^{(\text{late})}$ ). This enables the Power Transmitter to receive the Signal Strength Packet from the fast Power Receiver, but not from the slow one. However, the Power Transmitter cannot reliably receive any further communications—from either Power Receiver—due to collisions between transmissions from the two Power Receivers. Accordingly, the Power Transmitter cannot select a Primary Cell for power transfer.

**Figure 52. Two Power Receivers covering a single Primary Cell**

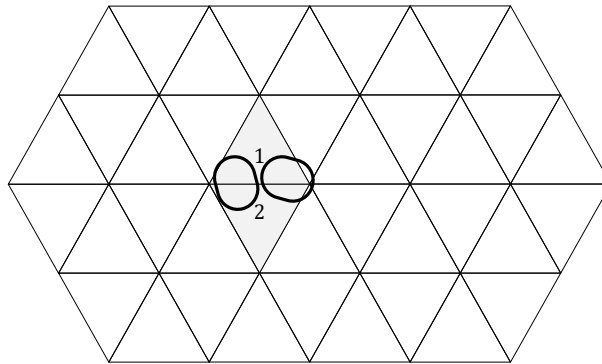



### B.3 Moving Primary Coil based Free Positioning

In the case of moving Primary Coil based Free Positioning, typically a special Detection Unit provides discovery and localization of a Power Receiver. This Annex B.3 discusses an example of such a Detection Unit, which makes use of the resonance in the Power Receiver at the detection frequency  $f_d$ . In this sample Detection Unit, detection coils are printed on the Interface Surface of the Base Station. The top right-hand part of Figure 53 shows a single rectangular detection coil, which consists of two windings. The width of the detection coil is 22 mm, and its length depends on the size of the Interface Surface. As shown in the bottom part of Figure 53, a first set of these detection coils is laid out in parallel to cover the entire Interface Surface in such a way that that the areas of two adjacent detection coils overlap by 60%. A second set of these detection coils is laid out similarly, but orthogonal to the detection coils in the first set.

Figure 53. Detection Coil

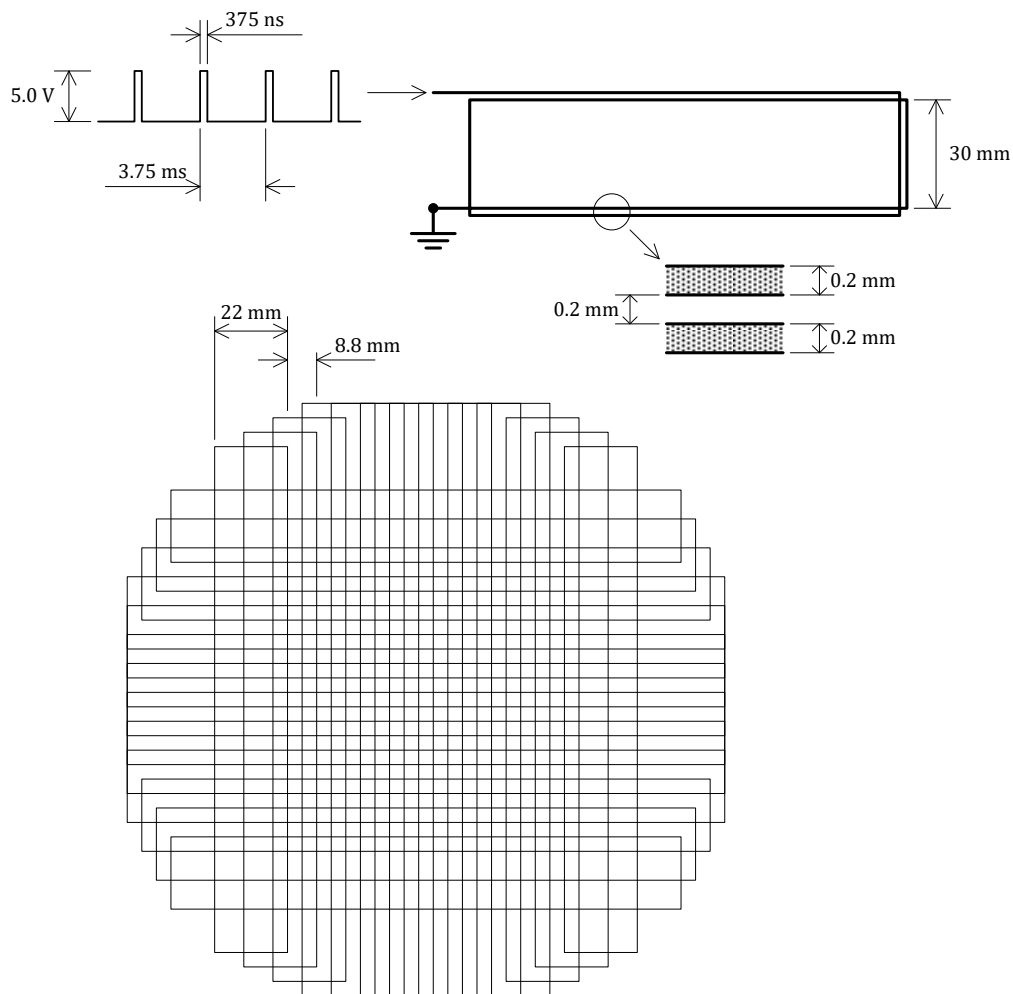

Detection of a Power Receiver proceeds as follows: In first instance, the Power Transmitter uses the detection coils as an electrostatic sensor to detect the placement or removal of objects on the Interface Surface (see Section 10, *Object Detection (Informative)*). Once the Power Transmitter has detected an object, it uses the detection coils to determine the position of that object on the Interface Surface. For this purpose, the Power Transmitter applies a short pulse train to each of the detection coils—one by one. This pulse train consists of 8 pulses, and is shaped to trigger the resonance in the Power Receiver at the frequency  $f_d$ . See the top left-hand part of Figure 53. As a result, a minute amount of energy is transferred to the resonant circuit in the Power Receiver. Immediately after the pulse train terminates, this energy is re-radiated, which the Power Transmitter can detect using the detection coils. By analyzing the responses from each of the detection coils, the Power Transmitter can determine the location of the Power Receiver on the Interface Surface. Subsequently, the Power Transmitter can move its coil underneath the Power Receiver, and can start to transfer power as defined in Section 5.1. During power transfer, the Power Transmitter can adjust the position of the Primary Coil in order to optimize its coupling to the Secondary Coil, e.g. by maximizing the system efficiency. The Power Transmitter can calculate the system efficiency from its input power and the Actual Power Value contained in the Actual Power Packets, which it receives from the Power Receiver.

An advantage of this detection method is that it is insensitive to Foreign Objects that do not exhibit a resonance near the detection frequency  $f_d$ . The reason is that such objects do not store and re-radiate energy picked up from the pulse train. Consequently, a Power Transmitter does not need to move the Primary Coil to attempt power transfer to such objects.

## B.4 User-assisted positioning

### B.4.1 Example 1

In the case of user-assisted positioning, typically a special Detection Unit provides discovery and localization of a Power Receiver so as to guide the user to move the Mobile Device towards the center of the Primary Coil. This section discusses an example of such a Detection Unit, which makes use of the resonance in the Power Receiver at the detection frequency  $f_d$ . In this sample Detection Unit, detection coils are printed on a circuit board underneath the Interface Surface of the Base Station.

The top left-hand part of Figure 54 shows a configuration of detection coils, which consists of a center detection coil aligned to the Primary Coil and a set of sectional detection coils surrounding the center detection coils. Typically, there are 8 sectional detection coils. The combination of all detection coils forms a circular detection area. The size of this circular detection area typically is equal to or larger than the area of the Primary Coil.

In order to excite the resonance signal from the Power Receiver, an outer excitation coil is formed close to the outer circumference of the sectional detection coils. If the detection area for user-assisted positioning is much larger than the area of Primary Coil, one or more inner excitation coils should be added.

Figure 54. Detection Unit

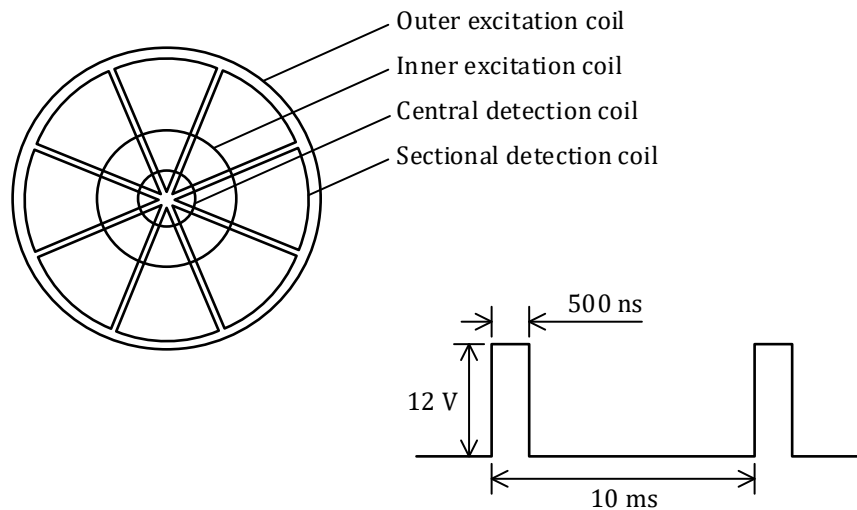

Basically, the Detection Unit uses the detection coils as an electromagnetic sensor array to determine the position of a Power Receiver on the Interface Surface. For this purpose, the Power Transmitter applies a short single pulse to an excitation coil, in order to trigger the resonance in the Power Receiver at the frequency  $f_d$ . See the bottom right-hand part of Figure 54. As a result, a minute amount of energy is transferred to the resonant circuit in the Power Receiver. Immediately after the pulse terminates, the energy is re-radiated and is captured by the detection coils as a response signal. After analyzing the distribution of responses from each of the detection coils, the Power Transmitter can determine the location of the Power Receiver on the Interface Surface. The Power Transmitter can use this information to provide feedback to the user, such that the user can properly move the Power Receiver towards the center of the Primary Coil of the Power Transmitter. If all sectional detection coils have approximately the same resonance level, the positioning is finished and then the Power Transmitter can start to transfer power as defined in Section 5.1. In addition, the circular detection coil at center is available for the detection of small Secondary Coils.

## B.4.2 Example 2

In the case of user-assisted positioning, typically a special Detection Unit provides discovery and localization of a Power Receiver so as to guide the user to move the Mobile Device towards the center of the Primary Coil. This section discusses an example of such a Detection Unit, which makes use of the resonance in the Power Receiver at the detection frequency  $fd$ . In this sample Detection Unit, detection coils are printed on a circuit board underneath the Interface Surface of the Base Station.

At first, a Clapp oscillator supplies its output signal to the Primary Coil, and a frequency sensor watches the output signal. If the Power Receiver comes near to the Primary Coil, the Shielding of the Power Receiver affects to the Primary Coil, and the frequency of the output signal is changed. If the frequency sensor detects the frequency change, the Clapp oscillator is stopped, and the Power transmitter starts to supply signal to the detection coils.

Figure 55 shows a configuration of detection coils, which consists of a center detection coil aligned to the Primary Coil, and a set of sectional detection coils surrounding the center detection coils. Typically, there are 4 sectional detection coils. The combination of all detection coils forms a circular detection area.

**Figure 55. Detection Coils**

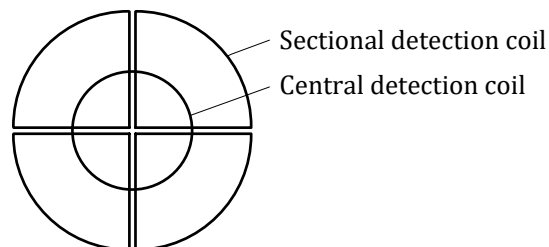

Basically, the Detection Unit uses the detection coils as an electromagnetic sensor array to determine the position of a Power Receiver on the Interface Surface. For this purpose, the Power Transmitter provides the signal at the frequency  $fd$ . Each detection coil's resonance level shows the location of the Power Receiver on the Interface Surface. The Power Transmitter can use this information to provide feedback to the user, such that the user can properly move the Power Receiver towards the center of the Primary Coil of the Power Transmitter.

## Annex C Power Receiver design guidelines (informative)

### C.1 Large-signal resonance check

In the course of designing a Power Receiver, it should be verified that the resonance frequency  $f_S$  of the dual resonant circuit remains within the tolerance range defined in Section 3.1.1, *Dual resonant circuit*, under large-signal conditions. The test defined in this Annex C.1 serves this purpose.

Step 1. Connect an RF power source to the assembly of Secondary Coil, Shielding and other components that influence the inductance of the Secondary Coil—e.g. a magnetic attractor, see Figure 7 on page 28—and series resonant capacitance  $C_S$ ; see Figure 56. The presence of the parallel capacitance  $C_p$  is optional.

Figure 56. Large signal secondary resonance test

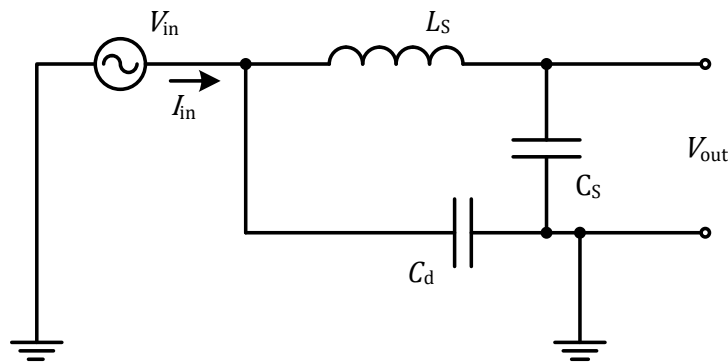

Step 2. Position the assembly and an appropriate spacer on primary Shielding material, as shown in Figure 7.

Step 3. Measure the input voltage  $V_{in}$  as a function of the frequency of the RF power source in the range of 90...110 kHz, while maintaining the input current  $I_{in}$  at a constant level, preferably at about twice the maximum value intended in the final product.

Step 4. Verify that the frequency at which the measured  $V_{in}$  is at a minimum, occurs within the specified tolerance range of the resonance frequency  $f_S$ .

## C.2 Power Receiver coil design

The mutual inductance  $M$  of a Secondary Coil, in combination with optional Shielding and other Mobile Device components, and the Primary Coil of a Power Transmitter design A10 should satisfy the following relations:

- $\frac{V_0}{\omega M} < 0.8 \text{ A}$ , if the Primary Coil and Secondary Coil centers are aligned; and
- $\frac{V_0}{\omega M} < 1.0 \text{ A}$ , if the Primary Coil and Secondary Coil centers have a lateral offset of  $5\sqrt{2} \text{ mm}$ .

Here  $V_0$  is the maximum output voltage expected from the Secondary Coil—or any other voltage that the Power Receiver designer considers relevant—and  $\omega = 2\pi f$ , with  $f = 100 \text{ kHz}$  the frequency at which the mutual inductance (in units of 1 henry) is measured.

## Annex D Mechanical Design Guidelines (Informative)

### D.1 Base Station

For the best user experience with respect to wireless power transfer, it is recommended that:

- The Base Station Interface Surface extends higher than its surroundings, or has a size of at least 107 mm×177 mm for the Baseline Power Profile.

For the Extended Power Profile, the recommended Base Station Interface Surface dimensions is at least 439 × 329 mm<sup>2</sup>.

- The Base Station Interface Surface is marked to indicate the location of its Active Area(s)—e.g. by means of the logo or other visual marking, lighting, etc.
- In the case of stand-alone Base Stations, the Active Area is centered within the Base Station Interface Surface.

### D.2 Mobile Device

The overall shape and size of a Mobile Device is dictated by its primary application. For example, cell phones, headsets, and digital (still) cameras, all have substantially different form factors. For the best user experience with respect to wireless power transfer, it is recommended that the mechanical design of a Mobile Device follows the guidelines listed below to the extent possible in relation to the primary application of the Mobile Device:

- The Mobile Device X, Y dimensions do not exceed 107 mm×177 mm for the Baseline Power Profile.

For the Extended Power Profile, Mobile Device X, Y dimensions do not exceed 439 × 329 mm<sup>2</sup>.

- The Mobile Device Interface Surface is flat.
- The Mobile Device Interface Surface is marked to indicate the location of its Active Area, e.g. by means of the logo or other visual marking.
- The location of the Active Area is centered within the Mobile Device Interface Surface.



### **D.3 Base Station Alignment Aid**

In order to ensure proper coupling between a Base Station and a Mobile Device, it is recommended that the Base Station employs one or more of the following Alignment Aids:

- A movable Active Area.
- A fixed visual marking of the Active Area on Interface Surface.
- Lighting that guides the user to align the Mobile Device.
- An audible signal that indicates when alignment is achieved.
- Tactile feedback that indicates when alignment is achieved.

### **D.4 Mobile Device Alignment Aid**

In order to ensure proper coupling between a Base Station and a Mobile Device, it is recommended that the Mobile Device employs one or more of the following Alignment Aids:

- An audible signal when alignment is achieved.
- Tactile feedback that indicates when alignment is achieved.
- A visual Response; e.g. a screen lighting up within 200 ms to indicate that power is received.
- An indication of wireless charging.

## Annex E History of Changes

NOTE The changes listed in Table 74 are limited to technical updates and other changes of significance made in version 1.2.3. The table does not identify minor editorial changes such as typographical errors.

**Table 74. Changes from version 1.2.2 to 1.2.3**

Location	Old	New	Reason
Section 1.4.2, References	[List of documents referenced in specification]	Updated list of documents with links and other information about how to find them.	Editorial update
Section 1.5, Definitions, Guaranteed Power definition	—	New paragraph: “...Depending on the context, <i>Guaranteed Power</i> can refer to the Guaranteed Power value contained in the Power Transfer Contract, or it can refer to the Guaranteed Power Value field contained in the Power Transmitter Capability Packet.”	Change request #375
Section 1.5, Definitions, Transmitted Power definition	The total amount of power dissipated outside the Interface Surface of a Base Station, due to the magnetic field generated by the Power Transmitter.	The total amount of power, <b>as measured by the Power Transmitter, that is</b> dissipated outside the Interface Surface of a Base Station, due to the magnetic field generated by the Power Transmitter.	Change request #375
Section 1.6, Acronyms	—	New acronyms added: BPP, EPP; GPV, PPV, PTC-GP, TP	Editorial update; Change request #375
Section 2.1.2, Alignment aid, first note	NOTE An example of such means is a piece of hard or soft magnetic material, which is attracted to the magnet provided in Power Transmitter design A1...	[Deleted the note. Power transmitter A1 has been deprecated.]	Change request #376

Location	Old	New	Reason
Section 3.1.9, Power consumption	—	In consideration of compliance testing (see <i>Part 3: Compliance Testing</i> ), a Power Receiver shall not drive the Transmitted Power of Test Power Transmitter #2 above 6500 mW or above the minimum of P_"max" +2500 mW and 7500 mW, where P_"max" is calculated as defined in Section 5.2.3.7, with the Power Receiver being positioned on TPT#2 such that power transfer can be sustained without interruption.	Restoration of previously-deleted text.
Section 5.1.2.3, Identification & configuration phase (PTx perspective), step 4 above Fig. 20	"...the Power Transmitter shall remove the Power Signal within $t_{start}$ after the <b>end</b> of the Configuration Packet."	"...the Power Transmitter shall remove the Power Signal within $t_{start}$ after the <b>start</b> of the Configuration Packet."	Change request #395
Section 5.1.2.6, Power transfer phase (PTx perspective), last page in section	<ul style="list-style-type: none"> <li>If the Power Transmitter receives a 24-bit Received Power Packet with Mode = '000'...</li> </ul>	[This bullet point has been substantially rewritten.]	Change request #386
Section 5.1.3.3, Identification & configuration phase (PRx perspective), "FOD extensions <b>not</b> supported" paragraph	FOD extensions not supported: After the Power Receiver has transmitted...	FOD extensions not supported: <b>The Power Receiver shall set the Neg bit in its Configuration packet to ZERO. It should also set the Polarity bit to ZERO and Depth field to 0x0.</b> After the Power Receiver has transmitted...	Change request #394

Location	Old	New	Reason
Section 5.1.3.3, Identification & configuration phase (PRx perspective), "FOD extensions supported" paragraph	"...If the Power Receiver does not receive an ACK Response..."	"...If the Power Receiver does not receive <b>the first bit of</b> an ACK Response..."	Change request #368
Section 5.1.3.6.1, FOD extension support, last bullet point	<ul style="list-style-type: none"> <li>▪ The Power Receiver may set the Mode field of the 24-bit Received Power Packet to...</li> </ul>	[This bullet point has been substantially rewritten.]	Change request #386
Section 5.1.4, State diagram (informative)	—	Updated Figure 34: removed "RP/nv" below the calibration phase.	Change request #395
Section 5.2.2.1, Modulation scheme	If the Power Receiver is properly aligned to the Primary Cell of a type A1 or MP-A1 Power Transmitter...	If the Power Receiver is properly aligned to the Primary Cell of a type <b>A10</b> or MP-A1 Power Transmitter...	Change request #376
Section 5.2.3.7 Configuration Packet (0x51)	<b>Neg</b> If this bit is set to ONE...	<b>Neg If this bit is set to ZERO, the Power Transmitter shall refrain from sending a Response.</b> If this bit is set to ONE...	Change request #394
Section 5.2.3.8, Identification Packet (0x71)	"The Minor Version field shall contain the binary coded digit value 0x2."	"The Minor Version field shall <b>be set according to the power profile of the Power Receiver.</b> [Table 36 added.]	Change request #394
Section 5.3.3.3, Power Transmitter Capability Packet (0x31), Guaranteed Power Value	"This field contains the amount of Guaranteed Power in units of 0.5 W."	"This field identifies the maximum Guaranteed Power value contained in the Power Transfer Contract (PTC-GP)..." [Extensive revision.]	Change request #375

Location	Old	New	Reason
Section 5.3.3.3, Power Transmitter Capability Packet (0x31), Potential Power Value	“This field contains the amount of Potential Power in units of 0.5 W.”	“This field identifies the maximum Guaranteed Power value contained in the Power Transfer Contract (PTC-GP)...” [Extensive revision.]	Change request #375
Section 5.3.3.3.1, Example of power transfer process under normal conditions	—	New section.	Change request #375
Section 5.3.3.3.2, Example of complete power transfer process with multiple events	—	New section.	Change request #375
Section 8.2.2, Extended Power Profile, Table 62	—	Deleted 15 W values from the 5 W column, and deleted the note, “These Test Power Receivers are designed to operate at a lower voltage if paired with a Low Power Transmitter.”	Change request #359
Section 8.3, Power Receiver efficiency, step 1	“1. Baseline Power Profile: Place the Power Receiver (Mobile Device) under test on the Interface Surface of Test Power Transmitter #1...”	“1. Baseline Power Profile: Position the Power Receiver (Mobile Device) under test on the Interface Surface of Test Power Transmitter #2...”	Change request #359
Section 10.1, Resonance shift	For a type A1 Power Transmitter...	For a type <b>A10</b> Power Transmitter...	Change request #376