

# SN5486, SN54LS86A, SN54S86 SN7486, SN74LS86A, SN74S86 QUADRUPLE 2-INPUT EXCLUSIVE-OR GATES

SDLS124 - DECEMBER 1972 - REVISED MARCH 1988

- Package Options Include Plastic "Small Outline" Packages, Ceramic Chip Carriers and Flat Packages, and Standard Plastic and Ceramic 300-mil DIPs
- Dependable Texas Instruments Quality and Reliability

TYPE	TYPICAL AVERAGE PROPAGATION DELAY TIME	TYPICAL TOTAL POWER DISSIPATION
'86	14 ns	150 mW
'LS86A	10 ns	30.5 mW
'S86	7 ns	250 mW

## description

These devices contain four independent 2-input Exclusive-OR gates. They perform the Boolean functions  $Y = A \oplus B = \bar{A}B + A\bar{B}$  in positive logic.

A common application is as a true/complement element. If one of the inputs is low, the other input will be reproduced in true form at the output. If one of the inputs is high, the signal on the other input will be reproduced inverted at the output.

The SN5486, 54LS86A, and the SN54S86 are characterized for operation over the full military temperature range of  $-55^{\circ}\text{C}$  to  $125^{\circ}\text{C}$ . The SN7486, SN74LS86A, and the SN74S86 are characterized for operation from  $0^{\circ}\text{C}$  to  $70^{\circ}\text{C}$ .

SN5486, SN54LS86A, SN54S86 . . . J OR W PACKAGE  
SN7486 . . . N PACKAGE  
SN74LS86A, SN74S86 . . . D OR N PACKAGE

(TOP VIEW)

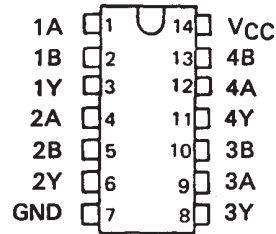

SN54LS86A, SN54S86 . . . FK PACKAGE

(TOP VIEW)

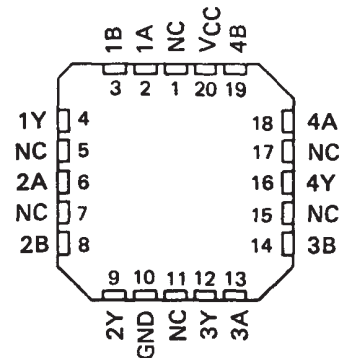

NC - No internal connection

## exclusive-OR logic

An exclusive-OR gate has many applications, some of which can be represented better by alternative logic symbols.

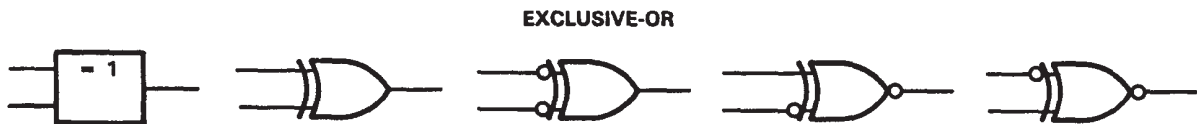

These are five equivalent Exclusive-OR symbols valid for an '86 or 'LS86A gate in positive logic; negation may be shown at any two ports.

**LOGIC IDENTITY ELEMENT**



The output is active (low) if all inputs stand at the same logic level (i.e.,  $A=B$ ).

**EVEN-PARITY**



The output is active (low) if an even number of inputs (i.e., 0 or 2) are active.

**ODD-PARITY ELEMENT**

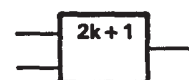

The output is active (high) if an odd number of inputs (i.e., only 1 of the 2) are active.

PRODUCTION DATA information is current as of publication date. Products conform to specifications per the terms of Texas Instruments standard warranty. Production processing does not necessarily include testing of all parameters.

 **TEXAS  
INSTRUMENTS**

POST OFFICE BOX 655303 • DALLAS, TEXAS 75265

Copyright © 1988, Texas Instruments Incorporated

# SN5486, SN54LS86A, SN54S86 SN7486, SN74LS86A, SN74S86 QUADRUPLE 2-INPUT EXCLUSIVE-OR GATES

SDLS124 – DECEMBER 1972 – REVISED MARCH 1988

## schematics of inputs and outputs

'86

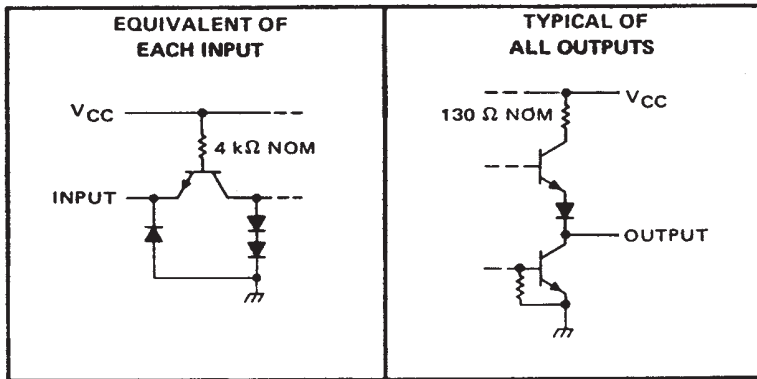

## logic symbol†

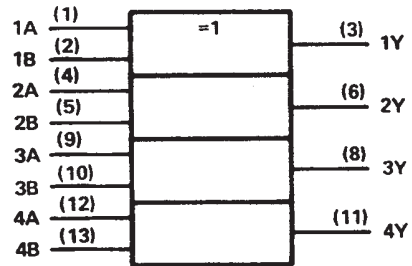

†This symbol is in accordance with ANSI/IEEE Std. 91-1984 and IEC Publication 617-12. Pin numbers shown are for D, J, N, and W packages.

'LS86A

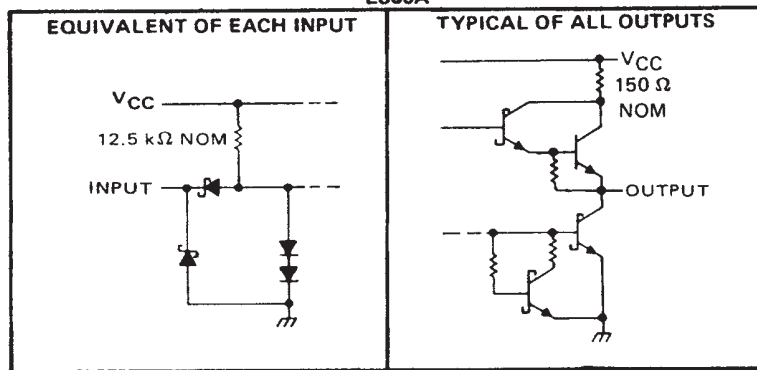

## FUNCTION TABLE

INPUTS		OUTPUT
A	B	Y
L	L	L
L	H	H
H	L	H
H	H	L

H = high level, L = low level

'S86

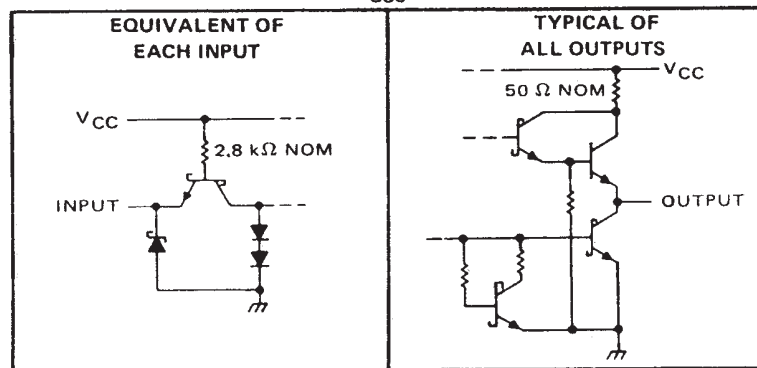

SN5486, SN54LS86A, SN54S86  
SN7486, SN74LS86A, SN74S86  
**QUADRUPLE 2-INPUT EXCLUSIVE-OR GATES**  
SDLS124 – DECEMBER 1972 – REVISED MARCH 1988

absolute maximum ratings over operating free-air temperature range (unless otherwise noted)

Supply voltage, $V_{CC}$ (see Note 1)	7	V
Input voltage	5.5	V
Operating free-air temperature range: SN5486	-55	°C to 125
SN7486	0	°C to 70
Storage temperature range	-65	°C to 150

NOTE 1: Voltage values are with respect to network ground terminal.

recommended operating conditions

	SN5486			SN7486			UNIT
	MIN	NOM	MAX	MIN	NOM	MAX	
Supply voltage, $V_{CC}$	4.5	5	5.5	4.75	5	5.25	V
High-level output current, $I_{OH}$			-800			-800	$\mu$ A
Low-level output current, $I_{OL}$			16			16	mA
Operating free-air temperature, $T_A$	-55		125	0		70	°C

electrical characteristics over recommended operating free-air temperature range (unless otherwise noted)

PARAMETER	TEST CONDITIONS†	SN5486			SN7486			UNIT	
		MIN	TYP‡	MAX	MIN	TYP‡	MAX		
$V_{IH}$ High-level input voltage		2			2			V	
$V_{IL}$ Low-level input voltage				0.8			0.8	V	
$V_{IK}$ Input clamp voltage	$V_{CC} = \text{MIN}, I_I = -8 \text{ mA}$			-1.5			-1.5	V	
$V_{OH}$ High-level output voltage	$V_{CC} = \text{MIN}, V_{IH} = 2 \text{ V}, V_{IL} = 0.8 \text{ V}, I_{OH} = -800 \mu\text{A}$	2.4	3.4		2.4	3.4		V	
$V_{OL}$ Low-level output voltage	$V_{CC} = \text{MIN}, V_{IH} = 2 \text{ V}, V_{IL} = 0.8 \text{ V}, I_{OL} = 16 \text{ mA}$		0.2	0.4		0.2	0.4	V	
$I_I$ Input current at maximum input voltage	$V_{CC} = \text{MAX}, V_I = 5.5 \text{ V}$			1			1	mA	
$I_{IH}$ High-level input current	$V_{CC} = \text{MAX}, V_I = 2.4 \text{ V}$			40			40	$\mu$ A	
$I_{IL}$ Low-level input current	$V_{CC} = \text{MAX}, V_I = 0.4 \text{ V}$			-1.6			-1.6	mA	
$I_{OS}$ Short-circuit output current§	$V_{CC} = \text{MAX}$			-20		-55	-18	-55	mA
$I_{CC}$ Supply current	$V_{CC} = \text{MAX}, \text{ See Note 2}$			30		43	30	50	mA

† For conditions shown as MIN or MAX, use the appropriate value specified under recommended operating conditions for the applicable type.

‡ All typical values are at  $V_{CC} = 5 \text{ V}, T_A = 25^\circ\text{C}$ .

§ Not more than one output should be shorted at a time.

NOTE 2:  $I_{CC}$  is measured with the inputs grounded and the outputs open.

switching characteristics,  $V_{CC} = 5 \text{ V}, T_A = 25^\circ\text{C}$

PARAMETER¶	FROM (INPUT)	TEST CONDITIONS		MIN	TYP	MAX	UNIT
$t_{PLH}$	A or B	Other input low	$C_L = 15 \text{ pF}, R_L = 400 \Omega,$		15	23	ns
$t_{PHL}$					11	17	
$t_{PLH}$	A or B	Other input high	See Note 3		18	30	ns
$t_{PHL}$					13	22	

¶  $t_{PLH}$  = propagation delay time, low-to-high-level output

$t_{PHL}$  = propagation delay time, high-to-low-level output

NOTE 3: Load circuits and voltage waveforms are shown in Section 1.



# SN5486, SN54LS86A, SN54S86 SN7486, SN74LS86A, SN74S86 QUADRUPLE 2-INPUT EXCLUSIVE-OR GATES

SDLS124 – DECEMBER 1972 – REVISED MARCH 1988

## absolute maximum ratings over operating free-air temperature range (unless otherwise noted)

Supply voltage, $V_{CC}$ (see Note 1)	7 V
Input voltage	7 V
Operating free-air temperature range: SN54LS86A	-55°C to 125°C
SN74LS86A	0°C to 70°C
Storage temperature range	-65°C to 150°C

NOTE 1: Voltage values are with respect to network ground terminal.

## recommended operating conditions

	SN54LS86A			SN74LS86A			UNIT
	MIN	NOM	MAX	MIN	NOM	MAX	
Supply voltage, $V_{CC}$	4.5	5	5.5	4.75	5	5.25	V
High-level output current, $I_{OH}$			-400			-400	$\mu$ A
Low-level output current, $I_{OL}$			4			8	mA
Operating free-air temperature, $T_A$	-55		125	0		70	°C

## electrical characteristics over recommended operating free-air temperature range (unless otherwise noted)

PARAMETER	TEST CONDITIONS†	SN54LS86A			SN74LS86A			UNIT
		MIN	TYP‡	MAX	MIN	TYP‡	MAX	
$V_{IH}$ High-level input voltage		2			2			V
$V_{IL}$ Low-level input voltage				0.7			0.8	V
$V_{IK}$ Input clamp voltage	$V_{CC} = \text{MIN}, I_I = -18 \text{ mA}$			-1.5			-1.5	V
$V_{OH}$ High-level output voltage	$V_{CC} = \text{MIN}, V_{IH} = 2 \text{ V}, V_{IL} = V_{IL \text{ max}}, I_{OH} = -400 \mu\text{A}$	2.5	3.4		2.7	3.4		V
$V_{OL}$ Low-level output voltage	$V_{CC} = \text{MIN}, I_{OL} = 4 \text{ mA}$		0.25	0.4		0.25	0.4	V
	$V_{CC} = \text{MIN}, V_{IH} = 2 \text{ V}, V_{IL} = V_{IL \text{ max}}, I_{OL} = 8 \text{ mA}$					0.35	0.5	
$I_I$ Input current at maximum input voltage	$V_{CC} = \text{MAX}, V_I = 7 \text{ V}$			0.2			0.2	mA
$I_{IH}$ High-level input current	$V_{CC} = \text{MAX}, V_I = 2.7 \text{ V}$			40			40	$\mu$ A
$I_{IL}$ Low-level input current	$V_{CC} = \text{MAX}, V_I = 0.4 \text{ V}$			-0.8			-0.8	mA
$I_{OS}$ Short-circuit output current§	$V_{CC} = \text{MAX}$	-20		-100	-20		-100	mA
$I_{CC}$ Supply current	$V_{CC} = \text{MAX}, \text{ See Note 2}$		6.1	10		6.1	10	mA

† For conditions shown as MIN or MAX, use the appropriate value specified under recommended operating conditions for the applicable type.

‡ All typical values are at  $V_{CC} = 5 \text{ V}, T_A = 25^\circ\text{C}$ .

§ Not more than one output should be shorted at a time.

NOTE 2:  $I_{CC}$  is measured with the inputs grounded and the outputs open.

## switching characteristics, $V_{CC} = 5 \text{ V}, T_A = 25^\circ\text{C}$

PARAMETER¶	FROM (INPUT)	TEST CONDITIONS		MIN	TYP	MAX	UNIT
$t_{PLH}$	A or B	Other input low	$C_L = 15 \text{ pF}, R_L = 2 \text{ k}\Omega,$ See Note 3		12	23	ns
$t_{PHL}$					10	17	
$t_{PLH}$	A or B	Other input high	See Note 3		20	30	ns
$t_{PHL}$					13	22	

¶  $t_{PLH}$  = propagation delay time, low-to-high-level output

$t_{PHL}$  = propagation delay time, high-to-low-level output

NOTE 3: Load circuits and voltage waveforms are shown in Section 1.



SN5486, SN54LS86A, SN54S86  
SN7486, SN74LS86A, SN74S86  
**QUADRUPLE 2-INPUT EXCLUSIVE-OR GATES**  
SDLS124 – DECEMBER 1972 – REVISED MARCH 1988

**absolute maximum ratings over operating free-air temperature range (unless otherwise noted)**

Supply voltage, $V_{CC}$ (see Note 1)	7 V
Input voltage	5.5 V
Operating free-air temperature range: SN54S86	–55°C to 125°C
SN74S86	0°C to 70°C
Storage temperature range	–65°C to 150°C

NOTE 1: Voltage values are with respect to network ground terminal.

**recommended operating conditions**

	SN54S86			SN74S86			UNIT
	MIN	NOM	MAX	MIN	NOM	MAX	
Supply voltage, $V_{CC}$	4.5	5	5.5	4.75	5	5.25	V
High-level output current, $I_{OH}$			–1			–1	mA
Low-level output current, $I_{OL}$			20			20	mA
Operating free-air temperature, $T_A$	–55		125	0		70	°C

**electrical characteristics over recommended operating free-air temperature range (unless otherwise noted)**

PARAMETER	TEST CONDITIONS†	SN54S86			SN74S86			UNIT
		MIN	TYP‡	MAX	MIN	TYP‡	MAX	
$V_{IH}$ High-level input voltage		2			2			V
$V_{IL}$ Low-level input voltage				0.8			0.8	V
$V_{IK}$ Input clamp voltage	$V_{CC} = \text{MIN}, I_I = -18 \text{ mA}$			–1.2			–1.2	V
$V_{OH}$ High-level output voltage	$V_{CC} = \text{MIN}, V_{IH} = 2 \text{ V}, V_{IL} = 0.8 \text{ V}, I_{OH} = -1 \text{ mA}$	2.5	3.4		2.7	3.4		V
$V_{OL}$ Low-level output voltage	$V_{CC} = \text{MIN}, V_{IH} = 2 \text{ V}, V_{IL} = 0.8 \text{ V}, I_{OL} = 20 \text{ mA}$			0.5			0.5	V
$I_I$ Input current at maximum input voltage	$V_{CC} = \text{MAX}, V_I = 5.5 \text{ V}$			1			1	mA
$I_{IH}$ High-level input current	$V_{CC} = \text{MAX}, V_I = 2.7 \text{ V}$			50			50	µA
$I_{IL}$ Low-level input current	$V_{CC} = \text{MAX}, V_I = 0.5 \text{ V}$			–2			–2	mA
$I_{OS}$ Short-circuit output current §	$V_{CC} = \text{MAX}$	–40		–100	–40		–100	mA
$I_{CC}$ Supply current	$V_{CC} = \text{MAX}, \text{ See Note 2}$		50	75		50	75	mA

† For conditions shown as MIN or MAX, use the appropriate value specified under recommended operating conditions for the applicable type.

‡ All typical values are at  $V_{CC} = 5 \text{ V}, T_A = 25^\circ\text{C}$ .

§ Not more than one output should be shorted at a time, and duration of the short-circuit should not exceed one second.

NOTE 2:  $I_{CC}$  is measured with the inputs grounded and the outputs open.

**switching characteristics,  $V_{CC} = 5 \text{ V}, T_A = 25^\circ\text{C}$**

PARAMETER¶	FROM (INPUT)	TEST CONDITIONS		MIN	TYP	MAX	UNIT
$t_{PLH}$	A or B	Other input low	$C_L = 15 \text{ pF}, R_L = 280 \Omega, \text{ See Note 3}$		7	10.5	ns
$t_{PHL}$				6.5	10		
$t_{PLH}$	A or B	Other input high			7	10.5	ns
$t_{PHL}$				6.5	10		

¶  $t_{PLH}$  = propagation delay time, low-to-high-level output

¶  $t_{PHL}$  = propagation delay time, high-to-low-level output

NOTE 3: Load circuits and voltage waveforms are shown in Section 1.



**PACKAGING INFORMATION**

Orderable Device	Status <sup>(1)</sup>	Package Type	Package Drawing	Pins	Package Qty	Eco Plan <sup>(2)</sup>	Lead/Ball Finish	MSL Peak Temp <sup>(3)</sup>
JM38510/07501BCA	ACTIVE	CDIP	J	14	1	TBD	A42 SNPB	N / A for Pkg Type
JM38510/07501BDA	ACTIVE	CFP	W	14	1	TBD	A42	N / A for Pkg Type
JM38510/07501BDA	ACTIVE	CFP	W	14	1	TBD	A42	N / A for Pkg Type
JM38510/30502B2A	ACTIVE	LCCC	FK	20	1	TBD	POST-PLATE	N / A for Pkg Type
JM38510/30502B2A	ACTIVE	LCCC	FK	20	1	TBD	POST-PLATE	N / A for Pkg Type
JM38510/30502BCA	ACTIVE	CDIP	J	14	1	TBD	A42 SNPB	N / A for Pkg Type
JM38510/30502BCA	ACTIVE	CDIP	J	14	1	TBD	A42 SNPB	N / A for Pkg Type
JM38510/30502BDA	ACTIVE	CFP	W	14	1	TBD	A42	N / A for Pkg Type
JM38510/30502BDA	ACTIVE	CFP	W	14	1	TBD	A42	N / A for Pkg Type
SN5486J	ACTIVE	CDIP	J	14	1	TBD	A42 SNPB	N / A for Pkg Type
SN5486J	ACTIVE	CDIP	J	14	1	TBD	A42 SNPB	N / A for Pkg Type
SN54LS86AJ	ACTIVE	CDIP	J	14	1	TBD	A42 SNPB	N / A for Pkg Type
SN54LS86AJ	ACTIVE	CDIP	J	14	1	TBD	A42 SNPB	N / A for Pkg Type
SN54S86J	ACTIVE	CDIP	J	14	1	TBD	A42 SNPB	N / A for Pkg Type
SN54S86J	ACTIVE	CDIP	J	14	1	TBD	A42 SNPB	N / A for Pkg Type
SN7486N	OBSOLETE	PDIP	N	14		TBD	Call TI	Call TI
SN7486N	OBSOLETE	PDIP	N	14		TBD	Call TI	Call TI
SN7486N3	OBSOLETE	PDIP	N	14		TBD	Call TI	Call TI
SN7486N3	OBSOLETE	PDIP	N	14		TBD	Call TI	Call TI
SN74LS86AD	ACTIVE	SOIC	D	14	50	Green (RoHS & no Sb/Br)	CU NIPDAU	Level-1-260C-UNLIM
SN74LS86AD	ACTIVE	SOIC	D	14	50	Green (RoHS & no Sb/Br)	CU NIPDAU	Level-1-260C-UNLIM
SN74LS86ADE4	ACTIVE	SOIC	D	14	50	Green (RoHS & no Sb/Br)	CU NIPDAU	Level-1-260C-UNLIM
SN74LS86ADE4	ACTIVE	SOIC	D	14	50	Green (RoHS & no Sb/Br)	CU NIPDAU	Level-1-260C-UNLIM
SN74LS86ADR	ACTIVE	SOIC	D	14	2500	Green (RoHS & no Sb/Br)	CU NIPDAU	Level-1-260C-UNLIM
SN74LS86ADR	ACTIVE	SOIC	D	14	2500	Green (RoHS & no Sb/Br)	CU NIPDAU	Level-1-260C-UNLIM
SN74LS86ADRE4	ACTIVE	SOIC	D	14	2500	Green (RoHS & no Sb/Br)	CU NIPDAU	Level-1-260C-UNLIM
SN74LS86ADRE4	ACTIVE	SOIC	D	14	2500	Green (RoHS & no Sb/Br)	CU NIPDAU	Level-1-260C-UNLIM
SN74LS86AN	ACTIVE	PDIP	N	14	25	Pb-Free (RoHS)	CU NIPDAU	N / A for Pkg Type
SN74LS86AN	ACTIVE	PDIP	N	14	25	Pb-Free (RoHS)	CU NIPDAU	N / A for Pkg Type
SN74LS86AN3	OBSOLETE	PDIP	N	14		TBD	Call TI	Call TI
SN74LS86AN3	OBSOLETE	PDIP	N	14		TBD	Call TI	Call TI
SN74LS86ANE4	ACTIVE	PDIP	N	14	25	Pb-Free (RoHS)	CU NIPDAU	N / A for Pkg Type
SN74LS86ANE4	ACTIVE	PDIP	N	14	25	Pb-Free (RoHS)	CU NIPDAU	N / A for Pkg Type
SN74LS86ANSR	ACTIVE	SO	NS	14	2000	Green (RoHS & no Sb/Br)	CU NIPDAU	Level-1-260C-UNLIM

Orderable Device	Status <sup>(1)</sup>	Package Type	Package Drawing	Pins	Package Qty	Eco Plan <sup>(2)</sup>	Lead/Ball Finish	MSL Peak Temp <sup>(3)</sup>
						no Sb/Br)		
SN74LS86ANSR	ACTIVE	SO	NS	14	2000	Green (RoHS & no Sb/Br)	CU NIPDAU	Level-1-260C-UNLIM
SN74LS86ANSRE4	ACTIVE	SO	NS	14	2000	Green (RoHS & no Sb/Br)	CU NIPDAU	Level-1-260C-UNLIM
SN74LS86ANSRE4	ACTIVE	SO	NS	14	2000	Green (RoHS & no Sb/Br)	CU NIPDAU	Level-1-260C-UNLIM
SN74S86D	ACTIVE	SOIC	D	14	50	Green (RoHS & no Sb/Br)	CU NIPDAU	Level-1-260C-UNLIM
SN74S86D	ACTIVE	SOIC	D	14	50	Green (RoHS & no Sb/Br)	CU NIPDAU	Level-1-260C-UNLIM
SN74S86DE4	ACTIVE	SOIC	D	14	50	Green (RoHS & no Sb/Br)	CU NIPDAU	Level-1-260C-UNLIM
SN74S86DE4	ACTIVE	SOIC	D	14	50	Green (RoHS & no Sb/Br)	CU NIPDAU	Level-1-260C-UNLIM
SN74S86DR	ACTIVE	SOIC	D	14	2500	Green (RoHS & no Sb/Br)	CU NIPDAU	Level-1-260C-UNLIM
SN74S86DR	ACTIVE	SOIC	D	14	2500	Green (RoHS & no Sb/Br)	CU NIPDAU	Level-1-260C-UNLIM
SN74S86DRE4	ACTIVE	SOIC	D	14	2500	Green (RoHS & no Sb/Br)	CU NIPDAU	Level-1-260C-UNLIM
SN74S86DRE4	ACTIVE	SOIC	D	14	2500	Green (RoHS & no Sb/Br)	CU NIPDAU	Level-1-260C-UNLIM
SN74S86N	ACTIVE	PDIP	N	14	25	Pb-Free (RoHS)	CU NIPDAU	N / A for Pkg Type
SN74S86N	ACTIVE	PDIP	N	14	25	Pb-Free (RoHS)	CU NIPDAU	N / A for Pkg Type
SN74S86N3	OBSOLETE	PDIP	N	14		TBD	Call TI	Call TI
SN74S86N3	OBSOLETE	PDIP	N	14		TBD	Call TI	Call TI
SN74S86NE4	ACTIVE	PDIP	N	14	25	Pb-Free (RoHS)	CU NIPDAU	N / A for Pkg Type
SN74S86NE4	ACTIVE	PDIP	N	14	25	Pb-Free (RoHS)	CU NIPDAU	N / A for Pkg Type
SN74S86NSR	ACTIVE	SO	NS	14	2000	Green (RoHS & no Sb/Br)	CU NIPDAU	Level-1-260C-UNLIM
SN74S86NSR	ACTIVE	SO	NS	14	2000	Green (RoHS & no Sb/Br)	CU NIPDAU	Level-1-260C-UNLIM
SN74S86NSRE4	ACTIVE	SO	NS	14	2000	Green (RoHS & no Sb/Br)	CU NIPDAU	Level-1-260C-UNLIM
SN74S86NSRE4	ACTIVE	SO	NS	14	2000	Green (RoHS & no Sb/Br)	CU NIPDAU	Level-1-260C-UNLIM
SNJ5486J	ACTIVE	CDIP	J	14	1	TBD	A42 SNPB	N / A for Pkg Type
SNJ5486J	ACTIVE	CDIP	J	14	1	TBD	A42 SNPB	N / A for Pkg Type
SNJ5486W	ACTIVE	CFP	W	14	1	TBD	A42	N / A for Pkg Type
SNJ5486W	ACTIVE	CFP	W	14	1	TBD	A42	N / A for Pkg Type
SNJ54LS86AFK	ACTIVE	LCCC	FK	20	1	TBD	POST-PLATE	N / A for Pkg Type
SNJ54LS86AFK	ACTIVE	LCCC	FK	20	1	TBD	POST-PLATE	N / A for Pkg Type
SNJ54LS86AJ	ACTIVE	CDIP	J	14	1	TBD	A42 SNPB	N / A for Pkg Type
SNJ54LS86AJ	ACTIVE	CDIP	J	14	1	TBD	A42 SNPB	N / A for Pkg Type

Orderable Device	Status <sup>(1)</sup>	Package Type	Package Drawing	Pins	Package Qty	Eco Plan <sup>(2)</sup>	Lead/Ball Finish	MSL Peak Temp <sup>(3)</sup>
SNJ54LS86AW	ACTIVE	CFP	W	14	1	TBD	A42	N / A for Pkg Type
SNJ54LS86AW	ACTIVE	CFP	W	14	1	TBD	A42	N / A for Pkg Type
SNJ54S86FK	ACTIVE	LCCC	FK	20	1	TBD	POST-PLATE	N / A for Pkg Type
SNJ54S86FK	ACTIVE	LCCC	FK	20	1	TBD	POST-PLATE	N / A for Pkg Type
SNJ54S86J	ACTIVE	CDIP	J	14	1	TBD	A42 SNPB	N / A for Pkg Type
SNJ54S86J	ACTIVE	CDIP	J	14	1	TBD	A42 SNPB	N / A for Pkg Type
SNJ54S86W	ACTIVE	CFP	W	14	1	TBD	A42	N / A for Pkg Type
SNJ54S86W	ACTIVE	CFP	W	14	1	TBD	A42	N / A for Pkg Type

<sup>(1)</sup> The marketing status values are defined as follows:

**ACTIVE:** Product device recommended for new designs.

**LIFEBUY:** TI has announced that the device will be discontinued, and a lifetime-buy period is in effect.

**NRND:** Not recommended for new designs. Device is in production to support existing customers, but TI does not recommend using this part in a new design.

**PREVIEW:** Device has been announced but is not in production. Samples may or may not be available.

**OBSELETE:** TI has discontinued the production of the device.

<sup>(2)</sup> Eco Plan - The planned eco-friendly classification: Pb-Free (RoHS), Pb-Free (RoHS Exempt), or Green (RoHS & no Sb/Br) - please check <http://www.ti.com/productcontent> for the latest availability information and additional product content details.

**TBD:** The Pb-Free/Green conversion plan has not been defined.

**Pb-Free (RoHS):** TI's terms "Lead-Free" or "Pb-Free" mean semiconductor products that are compatible with the current RoHS requirements for all 6 substances, including the requirement that lead not exceed 0.1% by weight in homogeneous materials. Where designed to be soldered at high temperatures, TI Pb-Free products are suitable for use in specified lead-free processes.

**Pb-Free (RoHS Exempt):** This component has a RoHS exemption for either 1) lead-based flip-chip solder bumps used between the die and package, or 2) lead-based die adhesive used between the die and leadframe. The component is otherwise considered Pb-Free (RoHS compatible) as defined above.

**Green (RoHS & no Sb/Br):** TI defines "Green" to mean Pb-Free (RoHS compatible), and free of Bromine (Br) and Antimony (Sb) based flame retardants (Br or Sb do not exceed 0.1% by weight in homogeneous material)

<sup>(3)</sup> MSL, Peak Temp. -- The Moisture Sensitivity Level rating according to the JEDEC industry standard classifications, and peak solder temperature.

**Important Information and Disclaimer:** The information provided on this page represents TI's knowledge and belief as of the date that it is provided. TI bases its knowledge and belief on information provided by third parties, and makes no representation or warranty as to the accuracy of such information. Efforts are underway to better integrate information from third parties. TI has taken and continues to take reasonable steps to provide representative and accurate information but may not have conducted destructive testing or chemical analysis on incoming materials and chemicals. TI and TI suppliers consider certain information to be proprietary, and thus CAS numbers and other limited information may not be available for release.

In no event shall TI's liability arising out of such information exceed the total purchase price of the TI part(s) at issue in this document sold by TI to Customer on an annual basis.



J (R-GDIP-T\*\*)

14 LEADS SHOWN

CERAMIC DUAL IN-LINE PACKAGE



DIM \ PINS **	14	16	18	20
A	0.300 (7,62) BSC	0.300 (7,62) BSC	0.300 (7,62) BSC	0.300 (7,62) BSC
B MAX	0.785 (19,94)	.840 (21,34)	0.960 (24,38)	1.060 (26,92)
B MIN	—	—	—	—
C MAX	0.300 (7,62)	0.300 (7,62)	0.310 (7,87)	0.300 (7,62)
C MIN	0.245 (6,22)	0.245 (6,22)	0.220 (5,59)	0.245 (6,22)



4040083/F 03/03

- NOTES:
- All linear dimensions are in inches (millimeters).
  - This drawing is subject to change without notice.
  - This package is hermetically sealed with a ceramic lid using glass frit.
  - Index point is provided on cap for terminal identification only on press ceramic glass frit seal only.
  - Falls within MIL STD 1835 GDIP1-T14, GDIP1-T16, GDIP1-T18 and GDIP1-T20.

W (R-GDFP-F14)

CERAMIC DUAL FLATPACK



- NOTES:
- A. All linear dimensions are in inches (millimeters).
  - B. This drawing is subject to change without notice.
  - C. This package can be hermetically sealed with a ceramic lid using glass frit.
  - D. Index point is provided on cap for terminal identification only.
  - E. Falls within MIL STD 1835 GDFP1-F14 and JEDEC MO-092AB

FK (S-CQCC-N\*\*)

LEADLESS CERAMIC CHIP CARRIER

28 TERMINAL SHOWN



- NOTES:
- A. All linear dimensions are in inches (millimeters).
  - B. This drawing is subject to change without notice.
  - C. This package can be hermetically sealed with a metal lid.
  - D. The terminals are gold plated.
  - E. Falls within JEDEC MS-004

N (R-PDIP-T\*\*)

PLASTIC DUAL-IN-LINE PACKAGE

16 PINS SHOWN



- NOTES:
- A. All linear dimensions are in inches (millimeters).
  - B. This drawing is subject to change without notice.
  - $\triangle C$  Falls within JEDEC MS-001, except 18 and 20 pin minimum body length (Dim A).
  - $\triangle D$  The 20 pin end lead shoulder width is a vendor option, either half or full width.

4040049/E 12/2002

D (R-PDSO-G14)

PLASTIC SMALL-OUTLINE PACKAGE



4040047-3/H 11/2006

- NOTES:
- A. All linear dimensions are in inches (millimeters).
  - B. This drawing is subject to change without notice.
  - $\triangle C$  Body length does not include mold flash, protrusions, or gate burrs. Mold flash, protrusions, or gate burrs shall not exceed .006 (0,15) per end.
  - $\triangle D$  Body width does not include interlead flash. Interlead flash shall not exceed .017 (0,43) per side.
  - E. Reference JEDEC MS-012 variation AB.

# MECHANICAL DATA

NS (R-PDSO-G\*\*)

PLASTIC SMALL-OUTLINE PACKAGE

14-PINS SHOWN



- NOTES:
- A. All linear dimensions are in millimeters.
  - B. This drawing is subject to change without notice.
  - C. Body dimensions do not include mold flash or protrusion, not to exceed 0,15.

## IMPORTANT NOTICE

Texas Instruments Incorporated and its subsidiaries (TI) reserve the right to make corrections, modifications, enhancements, improvements, and other changes to its products and services at any time and to discontinue any product or service without notice. Customers should obtain the latest relevant information before placing orders and should verify that such information is current and complete. All products are sold subject to TI's terms and conditions of sale supplied at the time of order acknowledgment.

TI warrants performance of its hardware products to the specifications applicable at the time of sale in accordance with TI's standard warranty. Testing and other quality control techniques are used to the extent TI deems necessary to support this warranty. Except where mandated by government requirements, testing of all parameters of each product is not necessarily performed.

TI assumes no liability for applications assistance or customer product design. Customers are responsible for their products and applications using TI components. To minimize the risks associated with customer products and applications, customers should provide adequate design and operating safeguards.

TI does not warrant or represent that any license, either express or implied, is granted under any TI patent right, copyright, mask work right, or other TI intellectual property right relating to any combination, machine, or process in which TI products or services are used. Information published by TI regarding third-party products or services does not constitute a license from TI to use such products or services or a warranty or endorsement thereof. Use of such information may require a license from a third party under the patents or other intellectual property of the third party, or a license from TI under the patents or other intellectual property of TI.

Reproduction of information in TI data books or data sheets is permissible only if reproduction is without alteration and is accompanied by all associated warranties, conditions, limitations, and notices. Reproduction of this information with alteration is an unfair and deceptive business practice. TI is not responsible or liable for such altered documentation.

Resale of TI products or services with statements different from or beyond the parameters stated by TI for that product or service voids all express and any implied warranties for the associated TI product or service and is an unfair and deceptive business practice. TI is not responsible or liable for any such statements.

Following are URLs where you can obtain information on other Texas Instruments products and application solutions:

### Products

Amplifiers	<a href="http://amplifier.ti.com">amplifier.ti.com</a>
Data Converters	<a href="http://dataconverter.ti.com">dataconverter.ti.com</a>
DSP	<a href="http://dsp.ti.com">dsp.ti.com</a>
Interface	<a href="http://interface.ti.com">interface.ti.com</a>
Logic	<a href="http://logic.ti.com">logic.ti.com</a>
Power Mgmt	<a href="http://power.ti.com">power.ti.com</a>
Microcontrollers	<a href="http://microcontroller.ti.com">microcontroller.ti.com</a>
Low Power Wireless	<a href="http://www.ti.com/lpw">www.ti.com/lpw</a>

### Applications

Audio	<a href="http://www.ti.com/audio">www.ti.com/audio</a>
Automotive	<a href="http://www.ti.com/automotive">www.ti.com/automotive</a>
Broadband	<a href="http://www.ti.com/broadband">www.ti.com/broadband</a>
Digital Control	<a href="http://www.ti.com/digitalcontrol">www.ti.com/digitalcontrol</a>
Military	<a href="http://www.ti.com/military">www.ti.com/military</a>
Optical Networking	<a href="http://www.ti.com/opticalnetwork">www.ti.com/opticalnetwork</a>
Security	<a href="http://www.ti.com/security">www.ti.com/security</a>
Telephony	<a href="http://www.ti.com/telephony">www.ti.com/telephony</a>
Video & Imaging	<a href="http://www.ti.com/video">www.ti.com/video</a>
Wireless	<a href="http://www.ti.com/wireless">www.ti.com/wireless</a>

Mailing Address: Texas Instruments  
Post Office Box 655303 Dallas, Texas 75265